

Model 333 HART® Tri-Loop™ HART-to-Analog Signal Converter



ROSEMOUNT®

FISHER-ROSEMOUNT™ Managing The Process Better.™

Model 333 HART[®] Tri-Loop[™] HART-to-Analog Signal Converter

HART Tri-Loop Software Revision 1
HART Tri-Loop Configurator Software Revision 1.02

NOTICE

Read this manual before working with the product. For personal and system safety, and for optimum product performance, make sure you thoroughly understand the contents before installing, using, or maintaining this product.

Within the United States, Rosemount Inc. has two toll-free assistance numbers.

Customer Central: 1-800-999-9307 (7:00 a.m. to 7:00 p.m. CST)
Technical support, quoting, and order-related questions.

North American Response Center: 1-800-654-7768 (24 hours a day – Includes Canada)
Equipment service needs.

For equipment service or support needs outside the United States, contact your local Rosemount representative.

⚠ CAUTION

The products described in this document are NOT designed for nuclear-qualified applications.

Using non-nuclear qualified products in applications that require nuclear-qualified hardware or products may cause inaccurate readings.

For information on Rosemount nuclear-qualified products, contact your local Rosemount Sales Representative.

SNF-0004

*Rosemount and the Rosemount logotype are registered trademarks of Rosemount Inc.
Tri-Loop, Multivariable, MV, and Hot Backup are trademarks of Rosemount Inc.
HART is a registered trademark of the HART Communication Foundation.
Microsoft and Windows are registered trademarks of Microsoft Corp.*

Cover Photo: 3095-005AB

Rosemount Inc.
8200 Market Boulevard
Chanhassen, MN 55317 USA
Tel 1-800-999-9307
Fax (612) 949-7001
© 1996, 1999 Rosemount, Inc.
<http://www.rosemount.com>



ROSEMOUNT[®]

FISHER-ROSEMOUNT[™] Managing The Process Better.[™]



Table of Contents

SECTION 1	Using This Manual	1-1
Introduction		
SECTION 2	System overview	2-2
Installation	Unpacking The HART Tri-loop	2-2
	Initial Inspection	2-3
	Model 3095 MV (or HART Multivariable Device)	2-3
	Alarms	2-3
	Failure Mode Alarm vs. Saturation Output Values	2-3
	Installation Considerations	2-4
	Mechanical Considerations	2-4
	Electrical Considerations	2-5
	Power Supply	2-5
	Installation Equipment	2-6
	Installation Procedure	2-6
	1. Review Installation Considerations	2-6
	2. Mount Tri-Loop on DIN Rail	2-6
	3. Wiring	2-6
	Configure the Model 3095 MV For Tri-loop Operation	2-8
	Select Process Variables	2-8
	Record Model 3095 MV Units	2-9
	Set the Model 3095 MV to Burst Mode	2-10
SECTION 3	Overview	3-1
Commissioning	Install The Tri-loop Configurator Software	3-1
	Minimum Equipment and Software	3-2
	Installation Procedure	3-2
	Configure the Tri-loop	3-3
	Help Files	3-3
	Connect the PC to the Tri-Loop	3-3
	Configuration Procedure	3-4
	Menu Structure	3-6

SECTION 4
Troubleshooting

SECTION 5
Specifications and
Reference Data

Ordering Information 5-1
Specifications 5-1
 Functional
 Specifications 5-1
 Performance Specifications 5-2
 Physical Specifications 5-2
Configuration Data Sheet 00806-0100-4754 5-3

Appendix A

Overview A-1
Installation A-1
Commissioning the Transmitter A-2
 Set the Transmitter to Burst Mode A-2
 Set Process Variable Output Order A-2
 Special Considerations A-3

Appendix B

Introduction B-1
Communicating with a HART Tri-Loop B-1
 Online Menu B-2
Connections and hardware B-4
Communicator Keys B-6
 Action Keys B-6
 Function Keys B-7
 Alphanumeric and Shift Keys B-7
 Fast Key Sequences B-8
 Fast Key Sequence Conventions B-8
 Fast Key Sequence Example B-8
Menus and Functions B-8
 Main Menu B-8
 Online Menu B-9
 Diagnostic Messages B-10

Introduction

USING THIS MANUAL

This manual provides installation, configuration, and troubleshooting instructions for the Model 333 HART® Tri-Loop™ HART-to-Analog Signal Converter and for its operation with the HART Tri-Loop Configurator Software. This manual also explains how to connect a HART Tri-Loop to the Model 3095 MV Mass Flow Transmitter.

This manual consists of the following chapters:

Section 2

Installation

explains how to install the HART Tri-Loop. This includes an installation flowchart, installation considerations, and field installation. This section also explains how to set up the Model 3095 MV to send HART burst commands.

Section 3

Commissioning

explains how to install the HART Tri-Loop Configuration software, and outlines the main steps to configure a HART Tri-Loop.

Section 4

Troubleshooting

provides troubleshooting suggestions for the most common operating problems.

Section 5

Specifications and Reference Data

includes specification data for the HART Tri-Loop, ordering information, and Configuration Data Sheet.

Appendix A

Model 3244MV

explains how to configure a Model 3244MV Smart Temperature Transmitter for operation with a HART Tri-Loop.

Appendix B

HART® Communicator

explains how to use the Model 275 HART Communicator to communicate with a HART Tri-Loop.

This section contains an installation flowchart, an overview of the Model 333 HART Tri-Loop, and procedures for installation and wiring. The suggested sequence of HART Tri-Loop installation and wiring is shown in Figure 2-1.

FIGURE 2-1. HART Tri-Loop Installation Flowchart.

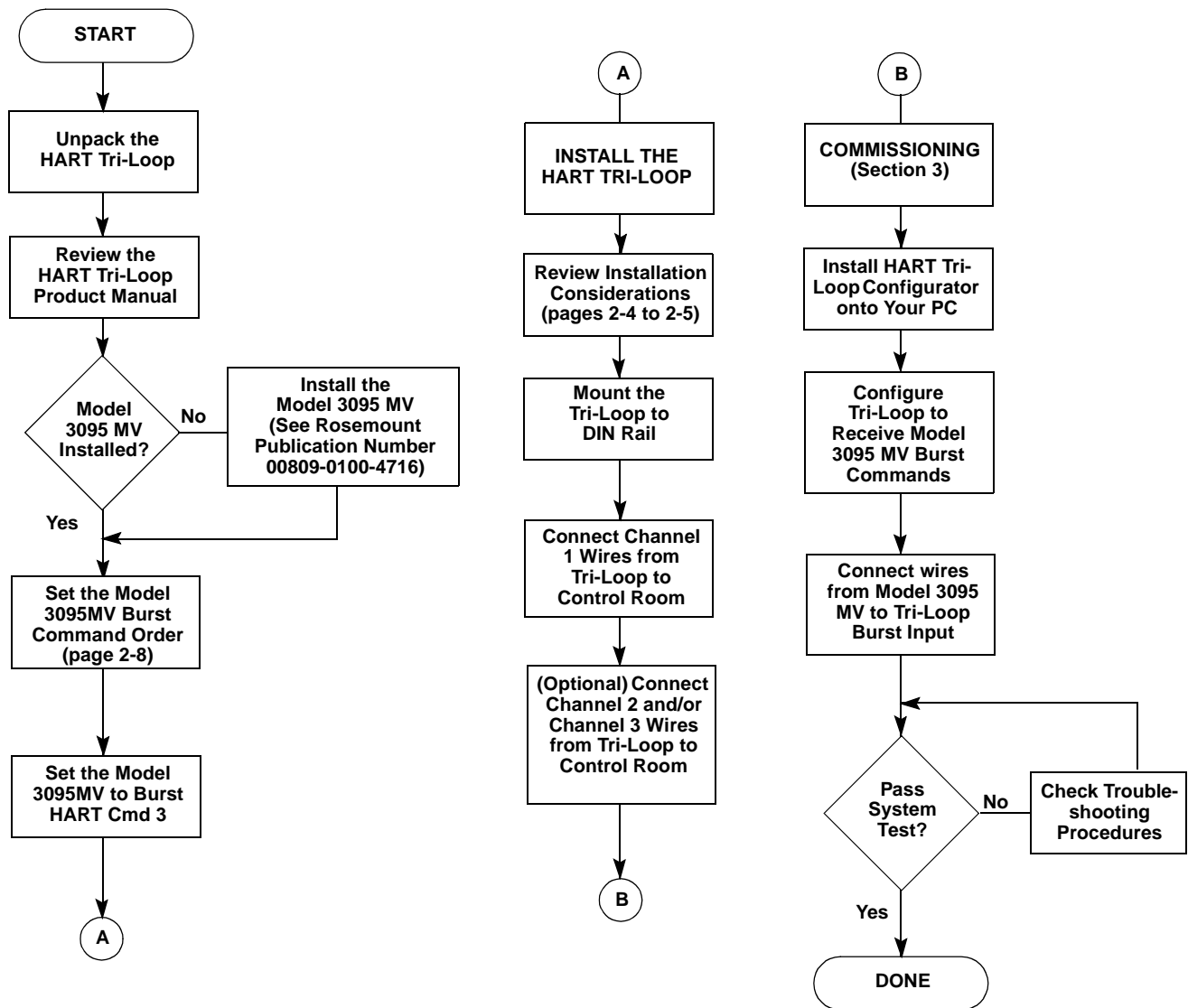

SYSTEM OVERVIEW

Figure 2-2 illustrates an installation where a Tri-Loop has been added to a Model 3095 MV installation.

The Tri-Loop design allows three different rail mounting options: asymmetrical 32mm G rail, symmetrical 35 × 7.5 mm top hat rail, and symmetrical 35 × 15 mm top hat rail. Since the Tri-Loop is designed for non-hazardous locations, the Tri-Loop can only be installed on the safe side of an IS barrier.

In this type of installation, the Model 3095 MV is configured to output HART Burst Command 3. The Tri-Loop converts each burst update to a corresponding analog value for up to three process variables. Any of the Model 3095 MV process variables can be provided via the Tri-Loop (DP, AP, GP, PT, or flow).

For each desired analog output, a separate pair of wires is installed from the Tri-Loop to the control room. However, Channel 1 wires must be installed and powered for the Tri-Loop to operate.

The initial Model 3095 MV analog output is not altered by the Tri-Loop installation.

UNPACKING THE HART TRI-LOOP

When custom configuration Tri-Loops are shipped, the filled-out configuration data sheet (CDS) is included in the box. If the CDS is separated from the configured Tri-Loop, the serial number on the side of the Tri-Loop can be matched with the serial number written on the CDS. A label is also printed on the side of the Tri-Loop identifying configuration information.

FIGURE 2-2. Example Tri-Loop Installation Site.

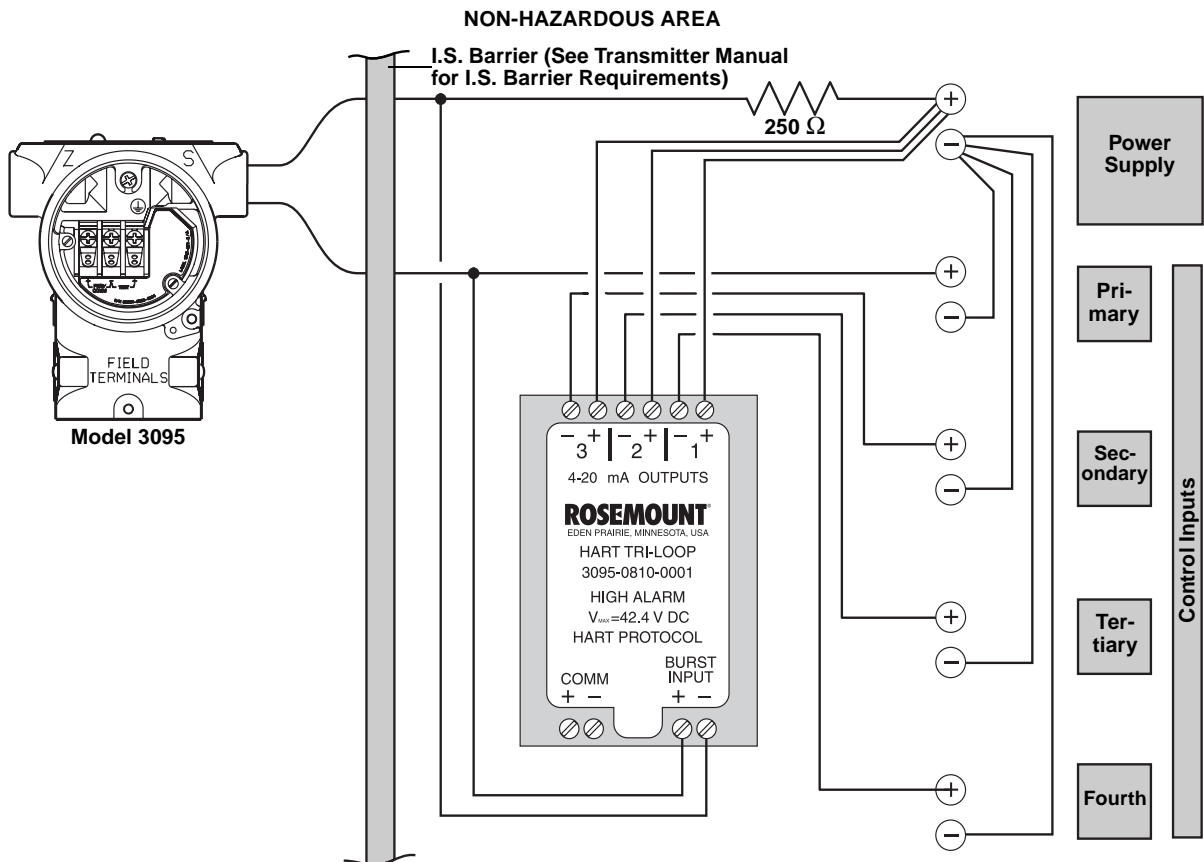

3095/3095_08A

Initial Inspection

1. Place the shipping containers on a secure bench and open them, taking care not to damage the contents.
2. Review the packing list to verify that all equipment was received.
3. Inspect the equipment and report any shipping damage to the carrier.

Model 3095 MV (or HART Multivariable Device)

Before mounting the Tri-Loop in the control room, the Model 3095 MV or HART Multivariable device must first be installed. Refer to the Model 3095 MV product manual (00809-0100-4716) for information on installing the Model 3095 MV.

Alarms

Tri-Loops are configured with all channels to alarm in the same direction. Alarm direction is configured at the factory, and cannot be changed in the field. In addition, all Tri-Loop channels will alarm if a Tri-Loop detects a sensor malfunction in the attached device.

Tri-Loops are ordered according to the desired alarm direction:

Tri-Loop Version	Part Number
High Alarm Tri-Loop	03095-0810-0001
Low Alarm Tri-Loop	03095-0810-0002
High Alarm Tri-Loop, Custom Configuration	03095-0810-0003
Low Alarm Tri-Loop, Custom Configuration	03095-0810-0004

Failure Mode Alarm vs. Saturation Output Values

The failure mode alarm output levels differ from the output values that occur when the measured value is outside the range points. When the measured value is outside the range points, the analog output continues to track the input value until reaching the saturation value listed below; the output does not exceed the listed saturation value regardless of the measured value. For example, for values outside the 4–20 range points, the output saturates at 3.9 mA or 20.8 mA.

When the Tri-Loop diagnostics detect a Tri-Loop failure or a Model 3095 MV malfunction, the analog outputs are set to an alarm value that differs from the saturation value to allow for proper troubleshooting.

NOTE

The output values listed below can be altered by an analog output trim procedure.

Level	4–20 mA Saturation Value	4–20 mA Alarm Value
Low	3.9 mA	< 3.75 mA
High	20.8 mA	> 21.75 mA

NOTE

If a Tri-Loop channel sets a range different than the attached device, the Tri-Loop range will be used.

For example, if a Model 3095 MV sets the primary variable to DP with a range of 0–250 inH₂O, and the Tri-Loop Configurator sets Tri-Loop channel 1 to receive this DP variable but enters a range of 0–100 inH₂O, the Tri-Loop will use the 0–100 inH₂O range.

**INSTALLATION
CONSIDERATIONS**

- Install the Tri-Loop in a location where it will be within the operating temperature specification of 50 to 104 °F (10 to 40 °C).
- A Tri-Loop can **NOT** be installed in hazardous areas.
- Wiring need not be shielded, but twisted pairs should be used for best results. Wiring should be between 24–12 AWG (solid or stranded) and not exceed 1,000 feet (305 meters).

**MECHANICAL
CONSIDERATIONS**

The Tri-Loop may be rail mounted on any of the DIN rails shown in Figure 2-3. Simply snap the Tri-Loop onto the rail in the desired location.

FIGURE 2-3. DIN Rail Mounting Options.



3095-060AB

SYMMETRICAL 35 X 7.5 MM TOP HAT RAIL

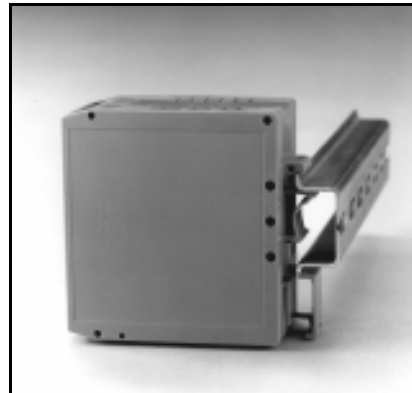

3095-059AB

SYMMETRICAL 35 X 15 MM TOP HAT RAIL



3095-068AB

ASYMMETRICAL 32MM G RAIL

FIGURE 2-4. Tri-Loop Dimensions.

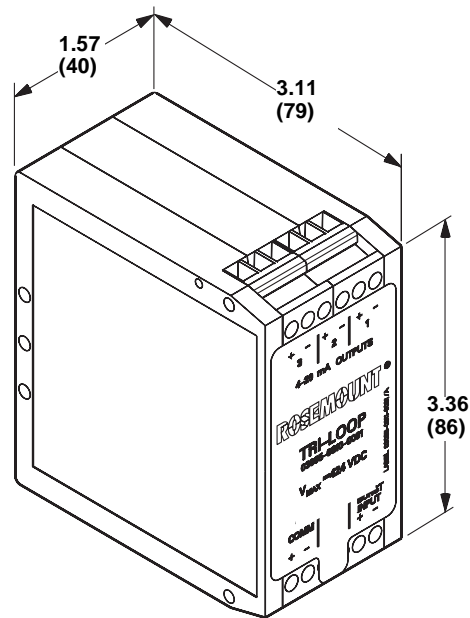

NOTE
Dimensions are in inches (millimeters).

3095-0810A01A

ELECTRICAL CONSIDERATIONS

Figure 2-5 illustrates power supply load limitations for each channel of the device. Each channel operates on terminal voltage of 11–42.4 V dc.

Channel 1 must be powered for Tri-Loop operation.

Power Supply

The dc power supply should provide power with less than 2% ripple. The total resistance load is the sum of the resistance of the signal leads and the load resistance of the controller, indicator, and related pieces.

FIGURE 2-5. Power Supply Load Limitations.

$$\text{Max. Loop Resistance} = \frac{\text{Power Supply Voltage} - 11.0}{0.022}$$

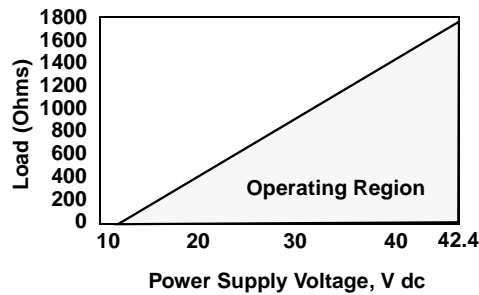

3051-0103A

NOTE

Wiring connections must be made in accordance with local or national installation codes such as the NEC NFPA 70.

INSTALLATION EQUIPMENT

The following equipment and tools are not provided with the HART Tri-Loop.

- Installation tools
- Wire between the control room and the Tri-Loop
- Wire between the Model 3095 MV and the Tri-Loop
- Power supply
- IS Barrier

INSTALLATION PROCEDURE

1. Review Installation Considerations

1. Review the installation considerations described on pages 2-4 through 2-5 in this chapter to determine the location for the HART Tri-Loop.

⚠ WARNING

Explosions can cause death or serious injury. The HART Tri-Loop is designed for installation in ordinary locations only. Do NOT install the HART Tri-Loop in hazardous locations.

2. Mount Tri-Loop on DIN Rail

2. Mount the HART Tri-Loop on any of the following DIN rails:
 - asymmetrical 32mm G rail,
 - symmetrical 35 × 7.5 mm top hat rail
 - symmetrical 35 × 15 mm top hat rail.

3. Wiring

3. Make wiring connections (see Figure 2-6).

NOTES

- Wiring need not be shielded, but twisted pairs should be used for best results.
- To ensure communication, wiring should be between 24–12 AWG (solid or stranded) and not exceed 1,000 feet (305 meters).

- a. Run wire from Tri-Loop Channel 1 to control room, and secure using screw clamps. Be sure to observe proper polarity. Include proper loop resistance (see page 2-5).
- b. (Optional) Run wire from Tri-Loop Channel 2 to control room, and secure using screw clamps. Be sure to observe proper polarity. Include proper loop resistance (see page 2-5).
- c. (Optional) Run wire from Tri-Loop Channel 3 to control room, and secure using screw clamps. Be sure to observe proper polarity. Include proper loop resistance (see page 2-5).
- d. Run wire from the Model 3095MV to BURST INPUT connections, but do not complete connections at this time. (See Figure 2-6).

NOTE

Tri-Loop commissioning will be much faster if the Tri-Loop does not have to compete with the Model 3095 MV burst commands. We therefore do not recommend completing the Burst Input connections until the Tri-Loop is commissioned (Chapter 3).

FIGURE 2-6. Tri-Loop Wiring Connections (Parallel Wiring).

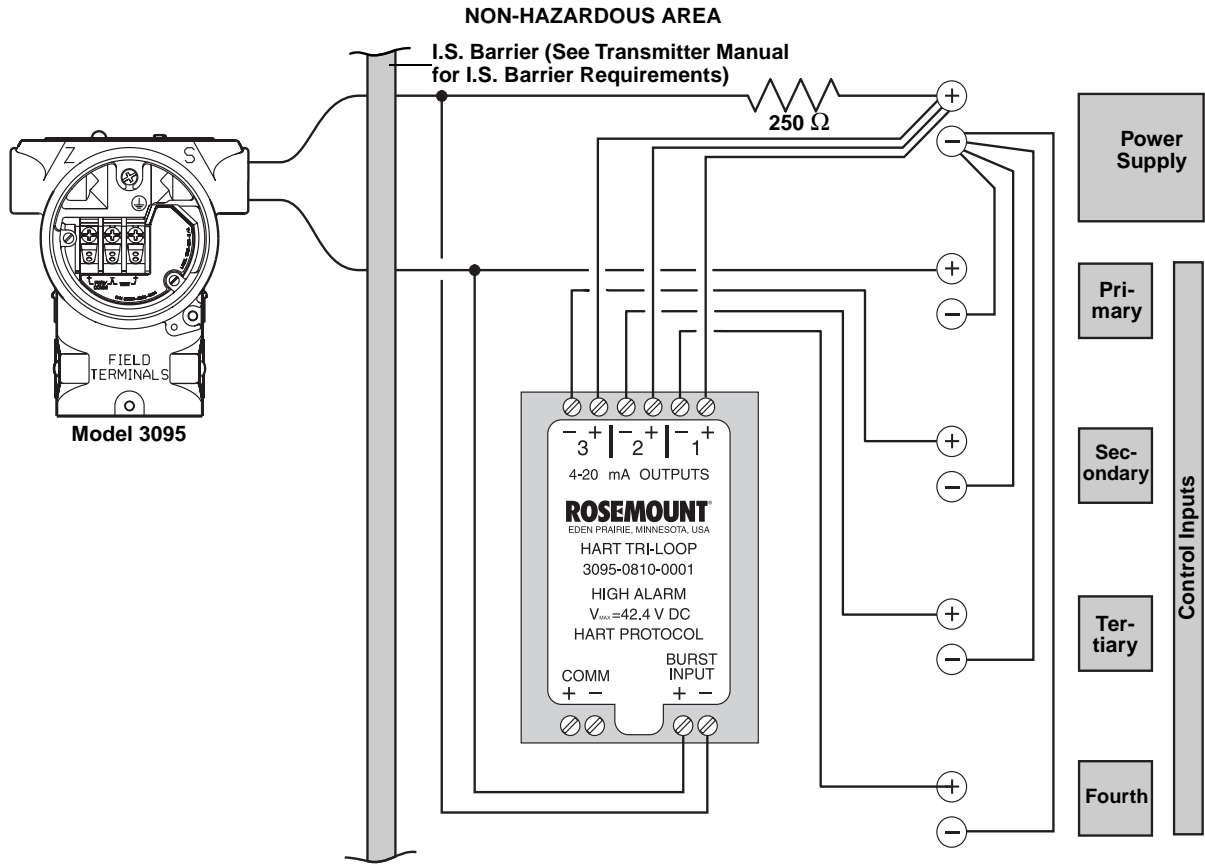

**CONFIGURE THE MODEL
3095 MV FOR TRI-LOOP
OPERATION**

The following information is an abbreviated guide for using the Model 3095 MV Engineering Assistant (EA) to configure the Model 3095 MV for operation with a HART Tri-Loop. For additional information on the EA or the Model 3095 MV, refer to the Model 3095 MV product manual (Rosemount publication number 00809-0100-4716).

Select Process Variables

- Maintenance**
- Analog Output**
- Range Values...**

This screen sets the range values for the primary variable, and also allows for reassigning the process variable output order. This determines both which process variables are burst by the Model 3095 MV, and in which order the variables are sent.

NOTE

The Primary Variable (Figure 2-7) is also assigned as the Model 3095 MV 4–20 mA analog output.

1. Using the Model 3095 MV EA, access the Range Values Screen (Maintenance, Analog Output, Range Values...).
2. Select Assign Variables, then set the desired variable order (see Figure 2-8).
3. Record the selected process variables in Table 2-1.

FIGURE 2-7. Range Values Screen.

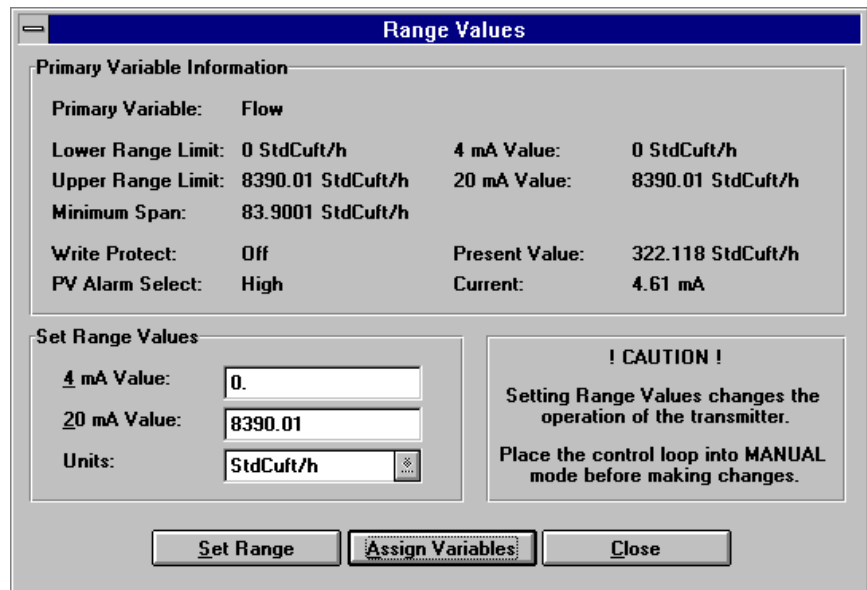
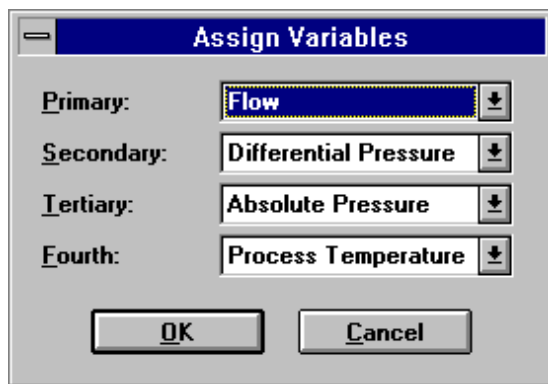

FIGURE 2-8. Assign Variables Screen.



Record Model 3095 MV Units

NOTE

The Tri-Loop will alarm if there is a unit mismatch between the Model 3095 MV and the Tri-Loop Channel.

To assist in Tri-Loop commissioning, (Section 3), we recommend that you record the Model 3095 MV process variables and units in Table 2-1.

Transmitter Units

This screen sets the units for the five process variables: Differential Pressure, Absolute Pressure, Gage Pressure, Process Temperature, and Flow Applications.

1. Using the Model 3095 MV Engineering Assistant, access the Transmitter, Units Screen.
2. If desired, change the displayed units. Modifying the information on this screen and selecting OK immediately changes the connected transmitter.
3. Record in Table 2-1 the selected units for each process variable.

FIGURE 2-9. Units Screen.

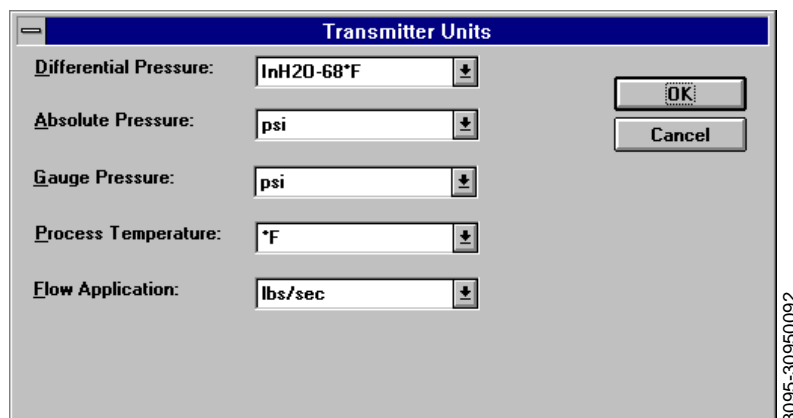

TABLE 2-1. Table for entering Model 3095 MV Process Variables and Units.

Model 3095 MV Process Variable	User-Assigned Variables	User-Assigned Units
Primary		
Secondary		
Tertiary		
Fourth		

Set the Model 3095 MV to Burst Mode

For the Tri-Loop to receive the process variables, the Model 3095 MV must be set to Burst Command 3. Burst mode is compatible with use of the analog signal. Burst mode applies only to the transmission of burst data, and does not affect the way other Model 3095 MV data is accessed.

Transmitter HART Output Burst Mode

1. Using the Model 3095 MV Engineering Assistant, access the Burst Mode Screen.
2. If required, click on the Burst Mode Enabled box.
3. Select Dynamic Variables and Current (HART Cmd 3), then select OK.

FIGURE 2-10. Burst Mode Screen.

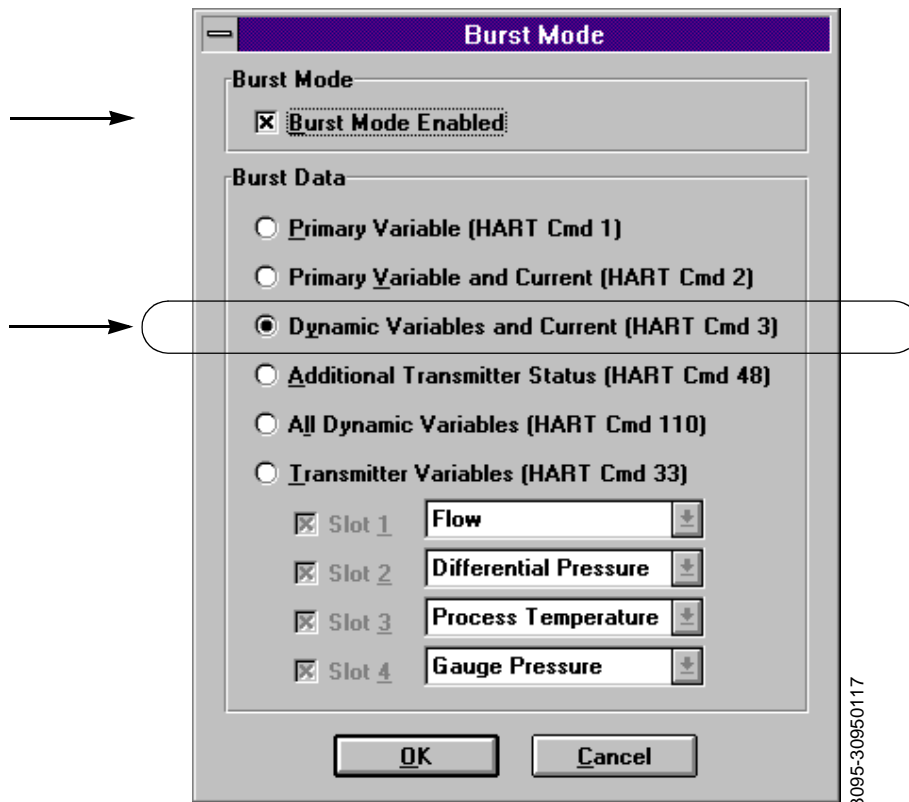

Commissioning

OVERVIEW

This section summarizes procedures needed to commission the HART Tri-Loop HART-to-Analog Signal Converter.

The following tasks are described in this section:

- Install the Tri-Loop Configurator software
- Configure the Tri-Loop
- Complete Burst Input Connection
- Perform system test

INSTALL THE TRI-LOOP CONFIGURATOR SOFTWARE

The HART Tri-Loop Configurator software package is available with or without the HART modem and connecting cables (see page 5-1 for part numbers). The complete Configurator package contains four 3.5-in. floppy disks, one HART modem, and a set of cables for connecting the computer to the HART Tri-Loop (see Figure 3-1).

FIGURE 3-1. Tri-Loop Configurator Software Equipment.

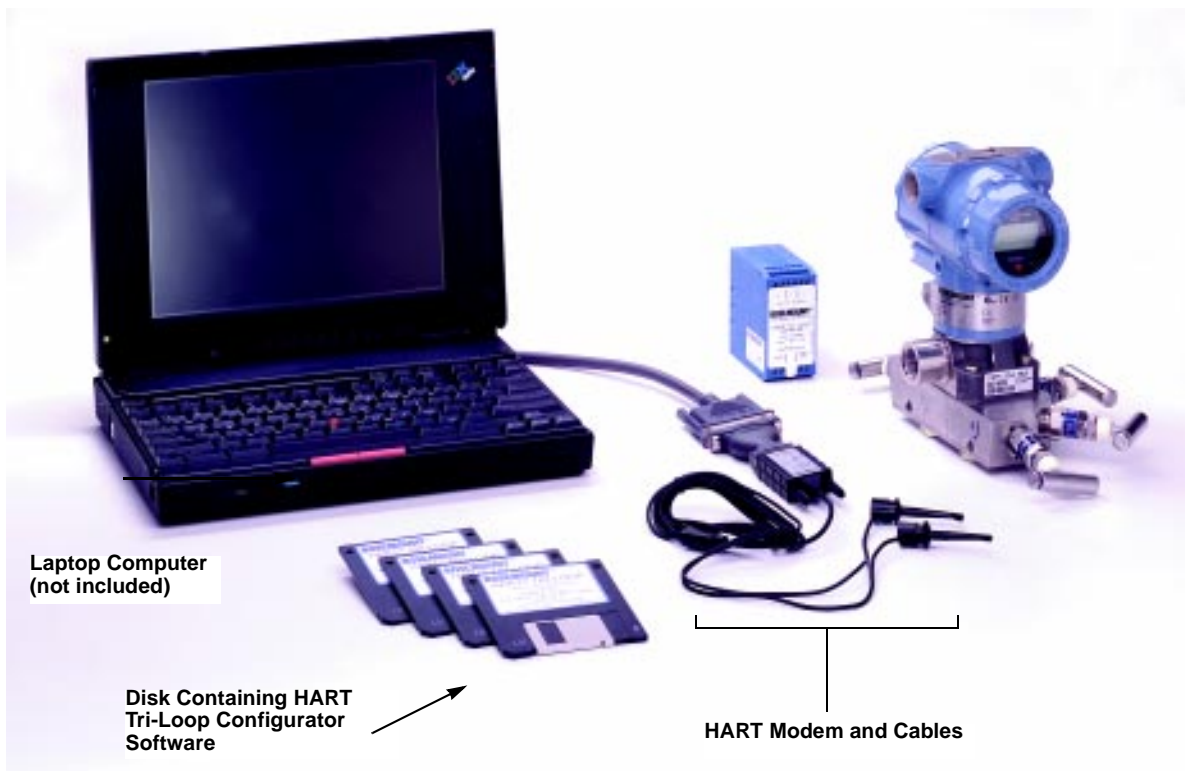

3095.tif

Minimum Equipment and Software

- MS-DOS based 386 computer or above
- MS DOS[®] 5.0 or higher
- 640K base RAM with 8 MB extended
- Microsoft[®] Windows[®] 3.1, Windows for Workgroups 3.11, or Windows 95
- Mouse or other pointing device (optional)
- Color computer display (optional)
- HART Tri-Loop Configurator Software, HART modem, set of modem cables

Installation Procedure

This procedure assumes that both DOS and Windows are already installed.

NOTE

In this manual, *return* indicates to press the return or enter key.

1. Power on the computer
2. After completion of boot-up procedures, verify that the computer is in Microsoft Windows. If the computer is at the DOS prompt (for example, C:\), type win *return* to start Windows.
3. Insert the floppy disk containing the first HART Tri-Loop Configurator Software into the personal computer disk drive.
4. Select File, then select Run from the Program Manager to display the Run window. Depending on the disk drive, enter either a: setup or b: setup, then click OK.
5. Follow the directions provided by the setup utility to install the HART Tri-Loop Configurator Software. Setup may require 3 or 4 disks, depending on the computer operating system.

NOTE

The HART communications port can be either COM1 or COM 2. The HART communications port must be different than the mouse port.

CONFIGURE THE TRI-LOOP

NOTE

Close the Model 3095 MV Engineering Assistant before opening the HART Tri-Loop Configurator Software. The Tri-Loop Configurator will not communicate with a Tri-Loop if the EA is open or minimized.

Help Files

The HART Tri-Loop Configurator Software contains a complete set of on-line help instructions.

When the Tri-Loop software is running on your computer, these help files are always available. To access these files, either click the Help button on any Tri-Loop screen, press the F1 key, or select a topic from the help menu.

Connect the PC to the Tri-Loop

When shipped from the factory, two quick-connect tabs are installed on the Tri-Loop COMM ports.

1. Connect the computer to the HART Tri-Loop (see Figure 3-1 and Figure 3-2).
 - a. Connect one end of the 9-pin to 9-pin cable to the HART communications port on the personal computer.
 - b. Connect the other end of the 9-pin to 9-pin cable to the HART modem.
 - c. Connect one end of the BNC cable to the HART modem.
 - d. Connect the mini-grabber cable to the other end of the BNC cable.
 - e. Connect the mini-grabbers to the two quick-connect tabs installed on the Tri-Loop COMM ports as shown in Figure 3-2.
2. Power on the computer.
3. (If necessary) Type win **return** at the DOS prompt.

FIGURE 3-2. Connecting to the Tri-Loop.

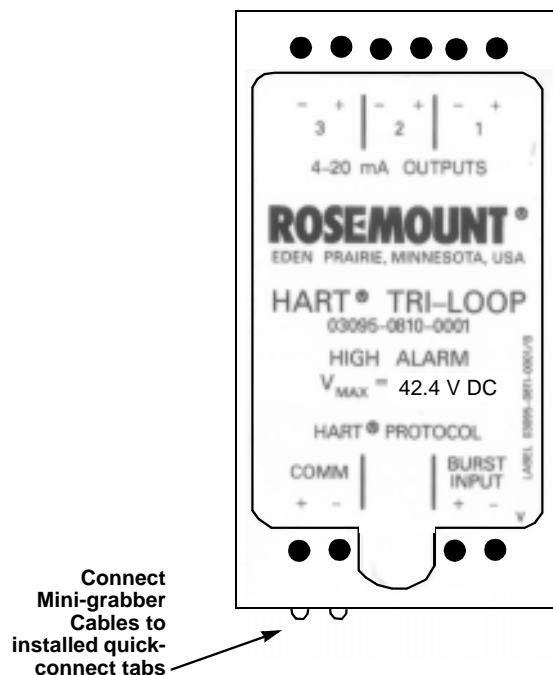

Configuration Procedure

The following procedure outlines the major steps needed to configure a Tri-Loop. For more detailed information, use the Configurator on-line help screens.

1. Double click on the HART Tri-Loop Configurator Software icon.
2. Select Tri-Loop, Connect to Tri-Loop to display the connect screen, then connect to a Tri-Loop.

NOTE

If you are unable to connect to a Tri-Loop, see Table 4-1 on page 4-1 for suggestions.

3. Select Configuration, Configure Channels to display the HART Tri-Loop Configuration Screen (Figure 3-3).
 - a. Click Channel 1, and select the process variable for this channel, desired range, and **exact** Model 3095 MV units. If required, click on the Enabled box so that the Tri-Loop analog output will be enabled.
 - b. (Optional) Repeat step a for Channels 2 and 3.
 - c. Click device information, enter the desired tag, descriptor, and message information, then select OK.
4. Select Configuration, Save to Tri-Loop to send the configuration to a Tri-Loop.
5. Select Configuration, Open from Tri-loop to verify that the configuration was correctly received. The Tri-Loop configuration information will be displayed in the main window of the HART Tri-Loop Configurator software.
6. If necessary, perform an analog output trim (Tri-Loop, Trim Outputs) for each enabled Tri-Loop analog output.
7. Complete the connection between the Model 3095 MV analog output and the Tri-Loop Burst Input as illustrated in Figure 3-4.
8. Use a multimeter or the control room equipment to verify that each new Tri-Loop channel is transmitting the Model 3095 MV process variables.

FIGURE 3-3. HART Tri-Loop Configuration Screen.

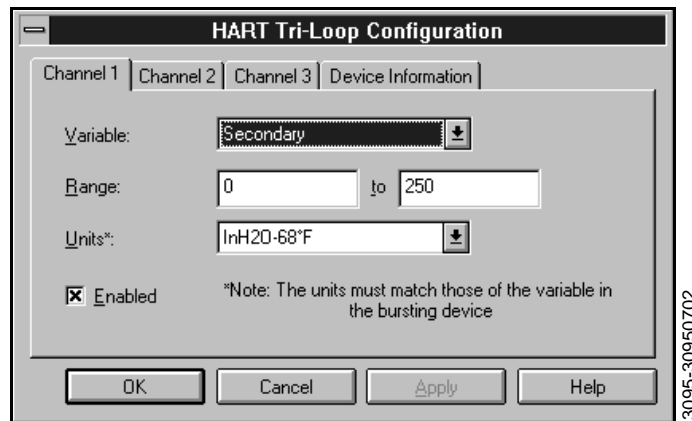
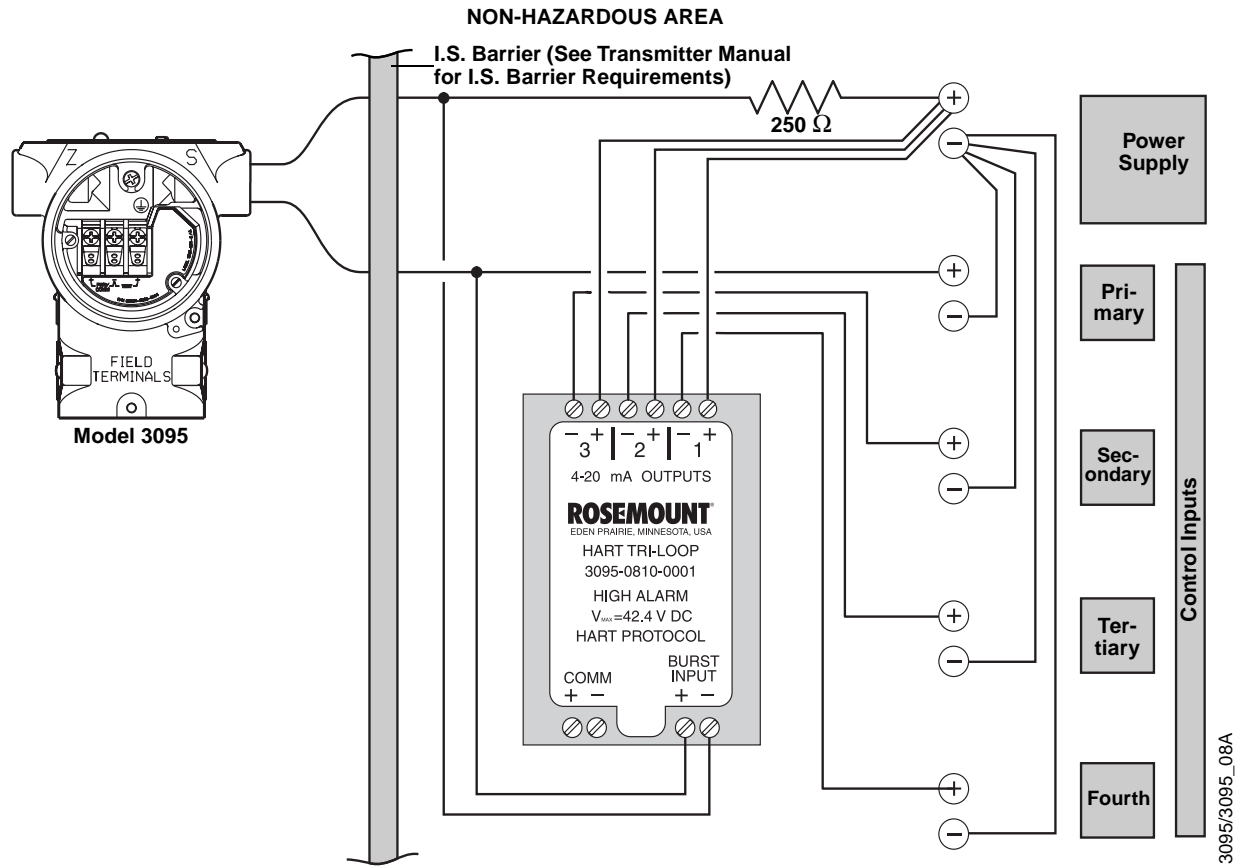

FIGURE 3-4. Tri-Loop Wiring Connections



MENU STRUCTURE

Figure 3-5 illustrates the complete menu structure for the HART Tri-Loop Configurator Software. For information on any of these menu items, refer to the Configurator on-line help files.

FIGURE 3-5. Configurator Menu Structure.

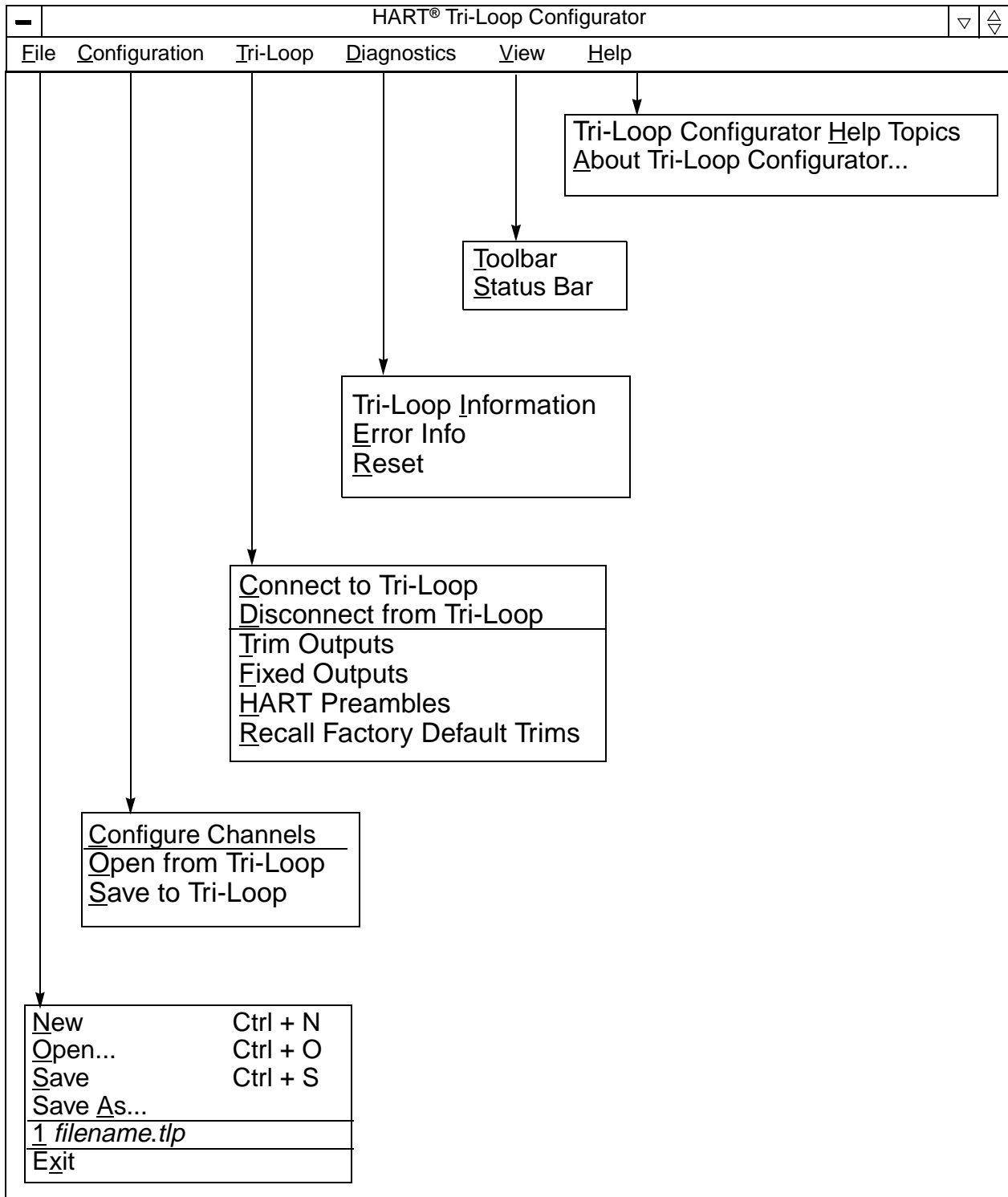

Troubleshooting

Table 4-1 provides troubleshooting suggestions for the most common operating problems.

TABLE 4-1. Tri-Loop Troubleshooting Table.

Symptom	Corrective Action
No Communication between the HART Tri-Loop Configurator Software and the Tri-Loop	<p>LOOP WIRING</p> <ul style="list-style-type: none"> • Close both EA software and Tri-Loop Configurator software, then restart the Tri-Loop Configurator software. • HART protocol communication requires a loop resistance value between 250–1100 ohms, inclusive. • Check for adequate voltage to the Tri-Loop. (Channel 1 must be powered for the Tri-Loop to operate.) • Check for intermittent shorts, open circuits, and multiple grounds. • Check for capacitance across the load resistor. Capacitance should be less than 0.1 microfarad. <p>TRI-LOOP SOFTWARE INSTALLATION</p> <ul style="list-style-type: none"> • Verify computer reboot followed software installation. • Verify correct COMM port selected. • Verify laptop computer is not in low energy mode (certain laptops disable all COMM ports in low energy mode). • Did you install software onto Windows NT platform? (Configurator software will only work with Windows 3.1, Windows for Workgroups 3.11, or Windows 95.) • Check if HART driver was subsequently over-written during a Model 3095 MV Engineering Assistant installation. If this has occurred, reinstall the Configurator software. • Check the DEVICEHIGH statement in the CONFIG.SYS statement as explained in the Configurator "readme" file.
Burst Commands not received from Model 3095 MV	<ul style="list-style-type: none"> • Verify the Model 3095 MV is set to Burst Command 3. • Check for adequate voltage to the Tri-Loop. (Channel 1 must be powered for the Tri-Loop to operate.) • Check for intermittent shorts, open circuits, and multiple grounds. • HART protocol communication requires a loop resistance value between 250–1100 ohms, inclusive. Typically, the required resistance is installed during the Model 3095 MV installation.
Tri-Loop Channel is in Alarm	<ul style="list-style-type: none"> • Use the HART Tri-Loop Configurator, and select <u>D</u>iagnostics, <u>E</u>rror Info to determine the cause of the alarm. For information on any error message, use the Configurator on-line help files.
Channel 1 operates correctly, but Channel 2 (or Channel 3) does not	<ul style="list-style-type: none"> • Check for proper loop resistance for the channel. Each channel must have it's own power supply and required loop resistance (see page 2-5).
Win32S error Runtime Error!	<ul style="list-style-type: none"> • If you receive a Win32s or Runtime error, remove Win32s and reinstall the Configurator software as explained in the Configurator "readme" file.

Specifications and Reference Data

This section contains the following reference data for the HART Tri-Loop HART-to-Analog Signal Converter:

- Ordering information
- Specifications
- Configuration Data Sheet (00806-0100-4754)

ORDERING INFORMATION

Model No. (Part No.)	Description
Model 333U (03095-0810-0001)	High Alarm Tri-Loop, Standard Configuration.
Model 333D (03095-0810-0002)	Low Alarm Tri-Loop, Standard Configuration.
Model 333UC2 (03095-0810-0003)	High Alarm Tri-Loop, Custom Configuration. Requires a completed Configuration Data Sheet (00806-0100-4754).
Model 333DC2 (03095-0810-0004)	Low Alarm Tri-Loop, Custom Configuration. Requires a completed Configuration Data Sheet (00806-0100-4754).
03095-0821-0001	HART Tri-Loop Configurator Software—Site License, HART Modem, Cables.
03095-0820-0002	HART Tri-Loop Configurator Software—Site License.
03095-5105-0001	HART Modem and Cables.

NOTE

There are no user-serviceable parts for the HART Tri-Loop.

SPECIFICATIONS

Functional Specifications

Service

Accessory product for the Model 3095 MV and Model 3244MV.

Output

One, two, or three 4–20 mA output signals, user-selectable for DP, AP, GP, PT, or flow.

Power Supply

External power supply required for each channel. Channel 1 must be powered for Tri-Loop operation. Each channel operates on terminal voltage of 11–42.4 V dc.

Turn-on Time

Analog signals will be within specifications five seconds after power is applied to Tri-Loop.

Installation Locations

Approved for FM ordinary locations.
Approved for CSA ordinary locations.

Load Limitations

Loop resistance is determined by the voltage level of the external power supply, as described by:

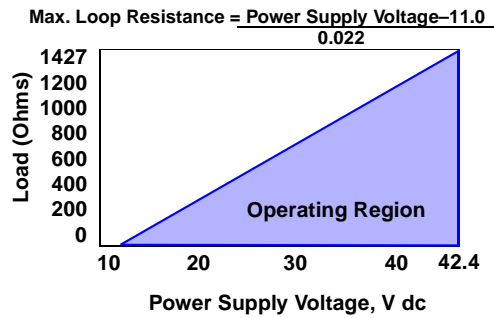

Temperature Limits

Ambient

50 to 104 °F (10 to 40 °C).

Storage

-40 to 158 °F (-40 to 70 °C).

Humidity Limits

0-95% non-condensing relative humidity.

Failure Mode Alarm

If Tri-Loop diagnostics detect a transmitter malfunction or a Tri-Loop failure, the analog signal will be driven either below 3.75 mA or above 21.75 mA to alert the user. The high or low alarm signal is selectable by the Tri-Loop Model Number.

Performance Specifications

NOTE

The performance specifications below are for the HART Tri-Loop only.

Reference Accuracy

±0.045% of span.

Ambient Temperature Effect per 50 °F (28 °C)

±0.15% of span.

Stability

±0.1% of span for 12 months.

Analog Output Update

Tri-Loop responds to every HART burst update.
(Typical transmitter burst update rate: 0.3 to 0.5 s.)

Tri-Loop Response Time (after each burst update)

Channel 1-120 ms; Channel 2-220 ms; Channel 3-320 ms.

Total Response Time

Typical response time from sensor change to transmitter to Tri-Loop analog update: 0.7 to 1.0 s.

Physical Specifications

Electrical Connections

Screw clamps. Accepts 24-12 AWG solid or stranded wire.

Dimensions

1.57 × 3.11 × 3.36 in. (40 × 79 × 85,5 mm)

DIN Rail Mounting Options

Asymmetrical 32mm G rail, symmetrical 35 × 7.5 mm top hat rail, or symmetrical 35 × 15 mm top hat rail.

Weight

0.27 lb (0,12 kg)

Model 3244MV

OVERVIEW

This appendix outlines the procedures necessary to install and commission a Model 3244MV Smart Temperature Transmitter for use with a HART Tri-Loop.

Use the HART Tri-Loop in conjunction with a Model 3244MV in operation with two sensors to acquire an independent 4–20 mA analog output signal for each sensor input. During normal operation, the 3244MV outputs four digital process variables: sensor 1, sensor 2, differential temperature, and transmitter terminal temperature. The HART Tri-Loop divides the digital signal and outputs any or all of these variables into as many as three separate 4–20 mA analog channels. You can also use the Tri-Loop with the 3244MV configured for differential temperature measurement or Hot Backup™ (see **Special Considerations** on page A-3).

Installation

Figure A-1 basic installation information. For complete installation information and procedures, refer to Section 2 Installation.

FIGURE A-1. HART Tri-Loop Installation Flowchart.

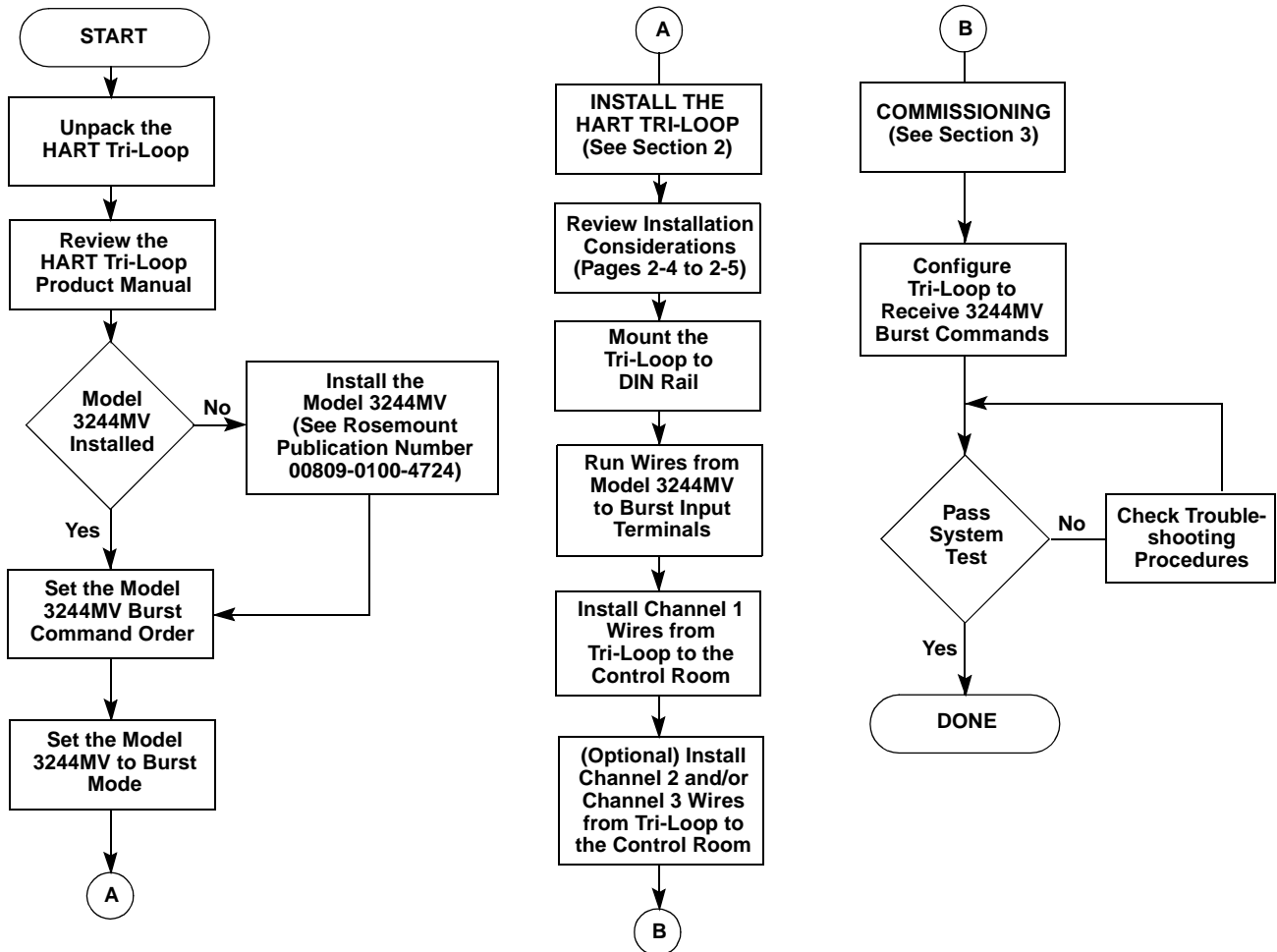

COMMISSIONING THE TRANSMITTER

To prepare a Model 3244MV for use with a HART Tri-Loop, you must configure the transmitter to Burst Command 3, and set the order of the process variables. In burst mode, the transmitter provides digital information for the analog current in mA to the Tri- Loop. The Tri-Loop divides the signal into separate 4–20 mA loops for the primary, secondary, tertiary, and fourth variables. When using the 3244MV in conjunction with the Tri-Loop, you must also consider the configuration of the differential temperature and hot backup features, if used. To commission a Model 3244MV for use with a HART Tri-Loop, perform the following procedures.

NOTE

These procedures assume that the sensor and transmitter are connected, powered, and functioning properly, and that a Model 275 HART Communicator is connected to the transmitter control loop and is communicating successfully. For information about connecting the communicator to the transmitter, refer to the Models 3144 and 3244MV Product Manual, Rosemount publication number 00809-0100-4724.

Set the Transmitter to Burst Mode

1. From the Home screen, Select *1 Device setup, 4 Detailed setup, 3 Output condition, 2 HART output, 4 Burst option* to prepare to set the transmitter to Burst Mode.

The communicator displays the Burst option screen.

2. Select *Process vars/crnt*.

The communicator returns to the HART output screen.

3. Select *3 Burst mode* to prepare to enable Burst Mode.

The communicator displays the Burst mode screen.

4. Select *On* to enable burst mode.

The communicator returns to the HART output screen.

5. Select “SEND” to download the new configuration information to the transmitter.

Set Process Variable Output Order

1. From the Home screen, select *1 Device setup, 1 Process variables, 7 Variable re-map*. Select “OK” to set the control loop to manual.

The communicator displays the Primary Variable screen.

2. Select the item you wish to set as the primary variable at the “Select PV” prompt.

3. Repeat step 2 for the SV, TV, and QV.

The communicator displays the Variable mapping screen.

4. Select “OK” to accept the order to which the variables are mapped, or “ABORT” to abort the entire procedure.

NOTE

Take careful note of the process variable output order. You must configure the Tri-Loop to read the variables in the same order.

5. Select “OK” to return the control loop to automatic control.

Special Considerations

To initiate operation between a Model 3244MV and the Tri-Loop, you must consider the configuration of the both the Differential Temperature and the Hot Backup features, if used. For complete information regarding the Differential Temperature and Hot Backup features, refer to the Models 3144 and 3244MV Product Manual, Rosemount publication number 00809-0100-4724.

Differential Temperature Measurement

To enable the differential temperature measurement feature of a 3244MV operating in conjunction with the Tri-Loop, adjust the range end points of the corresponding channel on the Tri-Loop to include zero. For example, if you wish the secondary variable of the 3244MV to report differential temperature, configure the transmitter accordingly (see **Set Process Variable Output Order** on page A-2), and adjust the corresponding channel of the Tri-Loop so one range end point is negative and the other is positive.

Hot Backup

To enable the Hot Backup feature of a Model 3244MV operating in conjunction with the Tri-Loop, ensure that the output units of the sensors are the same as the units of the Tri-Loop. You may use any combination of RTDs or thermocouples as long as the units of both match the units of the Tri-Loop.

NOTE

When configured for Hot Backup, if sensor 1 (primary) fails, sensor 2 automatically becomes the primary. An alarm does not occur unless sensor 2 also fails.

HART® Communicator

INTRODUCTION

This appendix provides basic communicator information on the HART Communicator Model 275 when used with a Tri-Loop. Included in this appendix are a menu tree, a table of fast key sequences, and information on using the HART communicator.

For more complete information on the HART Communicator, refer to the HART Communicator Product Manual 00809-0100-4275.

This brief appendix will familiarize you with the HART Communicator but is not meant to replace the HART Communicator product manual.

COMMUNICATING WITH A HART TRI-LOOP

The standard configuration for a Model 275 HART Communicator is to search for devices with HART address 0. The HART Tri-Loop, which is designed to work in conjunction with other HART devices, defaults to HART address 1. Therefore, before a HART Communicator can communicate with a HART Tri-Loop, you must first change a HART Communicator setting from "always poll" to "digital poll."

1. Select "4" Utility.
2. Select "1" Configure Communication.
3. Select "1" Polling.
4. Select "Digital Poll."

HART Tri-Loop HART-to-Analog Signal Converter

FIGURE B-1. HART Communicator Menu Tree for the Tri-Loop.

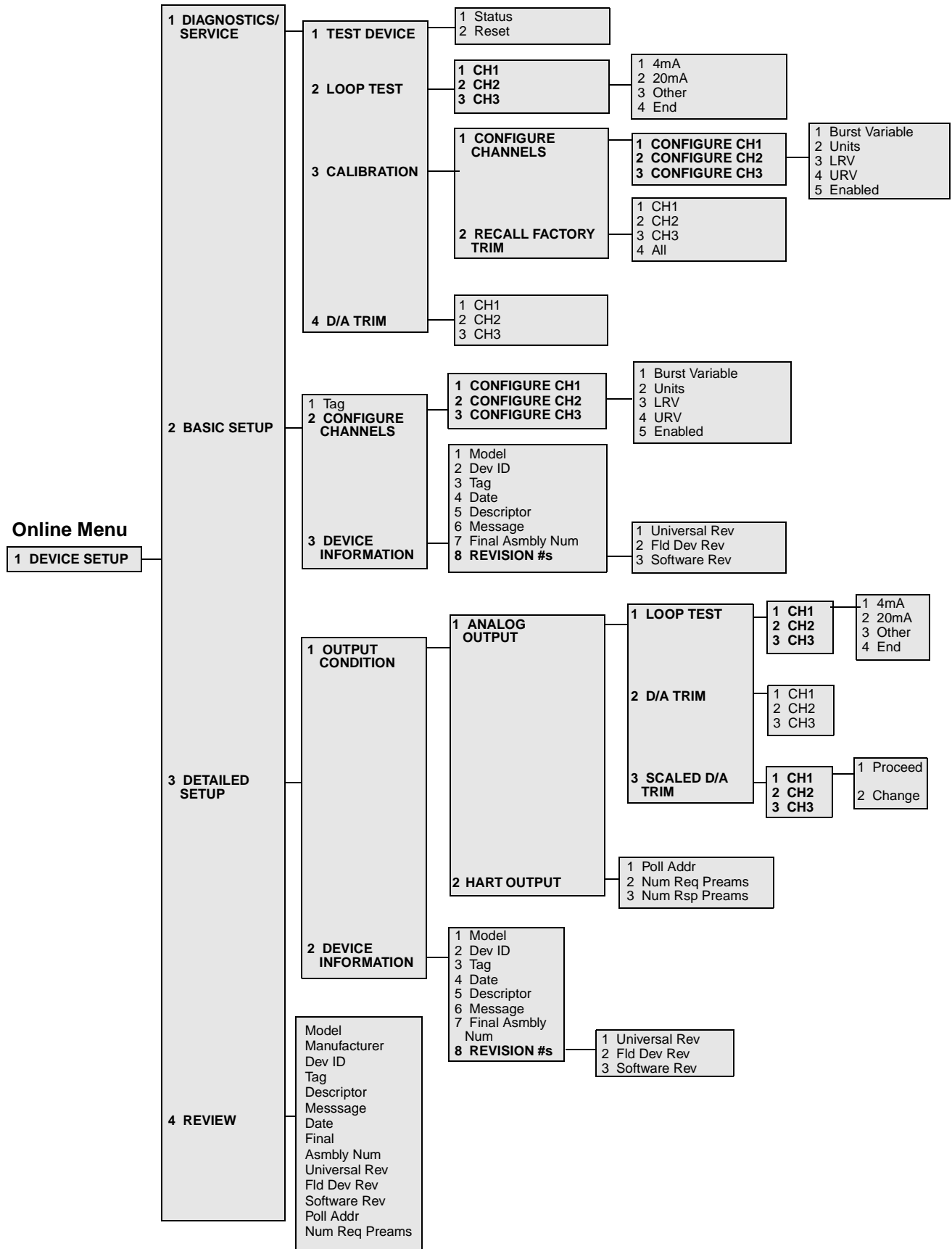

TABLE B-1. HART Fast Key Sequences for the Tri-Loop.

Function	HART Communicator Fast Key Sequences
20 mA (Loop Test)	1, 2, 1, 2
20 mA (Output Condition)	3, 1, 1, 1, 1, 2
4 mA (Loop Test)	1, 2, 1, 1
4 mA (Output Condition)	3, 1, 1, 1, 1, 1
All (Calibration)	1, 3, 2, 4
Burst Variable (Calibration)	1, 3, 1, 1, 1
Burst Variable (Configure Channels)	2, 2, 1, 1
CH1 (Calibration)	1, 3, 2, 1
CH1 (D/A TRIM)	1, 4, 1
CH1 (Output Condition)	3, 1, 1, 2, 1
CH2 (Calibration)	1, 3, 2, 2
CH2 (D/A TRIM)	1, 4, 2
CH2 (Output Condition)	3, 1, 1, 2, 2
CH3 (Calibration)	1, 3, 2, 3
CH3 (D/A TRIM)	1, 4, 3
CH3 (Output Condition)	3, 1, 1, 2, 3
Change (Scaled D/A Trim)	3, 1, 1, 3, 1, 2
Date (Basic Setup)	2, 3, 4
Date (Detailed Setup)	3, 2, 4
Descriptor (Basic Setup)	2, 3, 5
Descriptor (Detailed Setup)	3, 2, 5
Dev ID (Basic Setup)	2, 3, 2
Dev ID (Detailed Setup)	3, 2, 2
Enabled (Calibration)	1, 3, 1, 1, 5
Enabled (Configure Channels)	2, 2, 1, 5
End (Loop Test)	1, 2, 1, 4
End (Output Condition)	3, 1, 1, 1, 1, 4
Final Asmby Num (Basic Setup)	2, 3, 7
Final Asmby Num (Detailed Setup)	3, 2, 7

Function	HART Communicator Fast Key Sequences
Fld Dev Rev (Basic Setup)	2, 3, 8, 2
Fld Dev Rev (Detailed Setup)	3, 2, 8, 2
LRV (Calibration)	1, 3, 1, 1, 3
LRV (Configure Channels)	2, 2, 1, 3
Message (Basic Setup)	2, 3, 6
Message (Detailed Setup)	3, 2, 6
Model (Basic Setup)	2, 3, 1
Model (Detailed Setup)	3, 2, 1
Num Req Preams	3, 1, 2, 2
Num Rsp Preams	3, 1, 2, 3
Other (Loop Test)	1, 2, 1, 3
Other (Output Condition)	3, 1, 1, 1, 1, 3
Poll Addr	3, 1, 2, 1
Proceed (Scaled D/A Trim)	3, 1, 1, 3, 1, 1
Reset	1, 1, 2
Software Rev (Basic Setup)	2, 3, 8, 3
Software Rev (Detailed Setup)	3, 2, 8, 3
Status	1, 1, 1
Tag	2, 1
Tag (Basic Setup)	2, 3, 3
Tag (Detailed Setup)	3, 2, 3
Units (Calibration)	1, 3, 1, 1, 2
Units (Configure Channels)	2, 2, 1, 2
Universal Rev (Basic Setup)	2, 3, 8, 1
Universal Rev (Detailed Setup)	3, 2, 8, 1
URV (Calibration)	1, 3, 1, 1, 4
URV (Configure Channels)	2, 2, 1, 4

CONNECTIONS AND HARDWARE

The HART Communicator Model 275 can interface with a transmitter from the control room, the instrument site, or any wiring termination point in the loop through the rear connection panel as shown in Figure B-2. To communicate, connect the HART Communicator in parallel with the instrument or load resistor. The connections are non-polarized.

⚠ WARNING

Explosions can result in death or serious injury. Do not make connections to the serial port or NiCad recharger jack in an explosive atmosphere.

FIGURE B-2. Rear Connection Panel with Optional NiCad Recharger Pack.

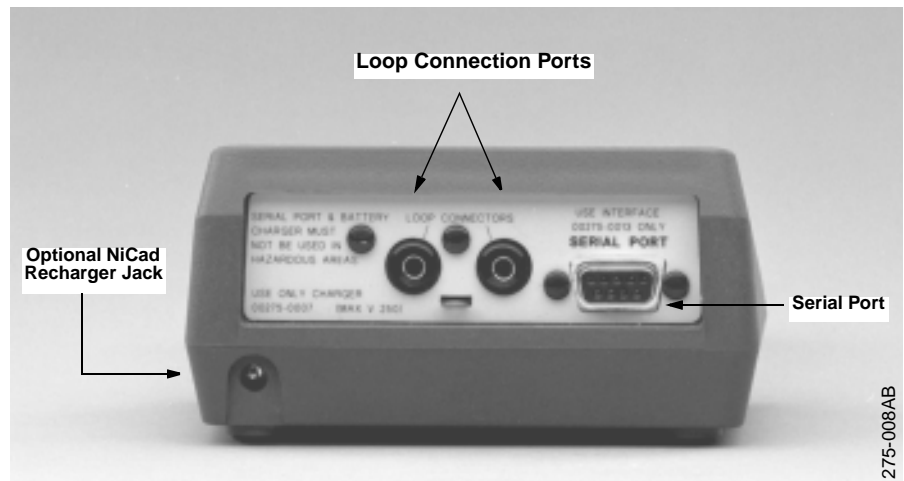

⚠ WARNING

Explosions can result in death or serious injury. Before connecting the HART Communicator in an explosive atmosphere, make sure the instruments in the loop are installed in accordance with intrinsically safe or nonincendive field wiring practices.

NOTE

The HART Communicator needs a minimum of 250 ohms resistance in the loop to function properly. The HART Communicator does not measure loop current directly.

FIGURE B-3. Wiring Connections.

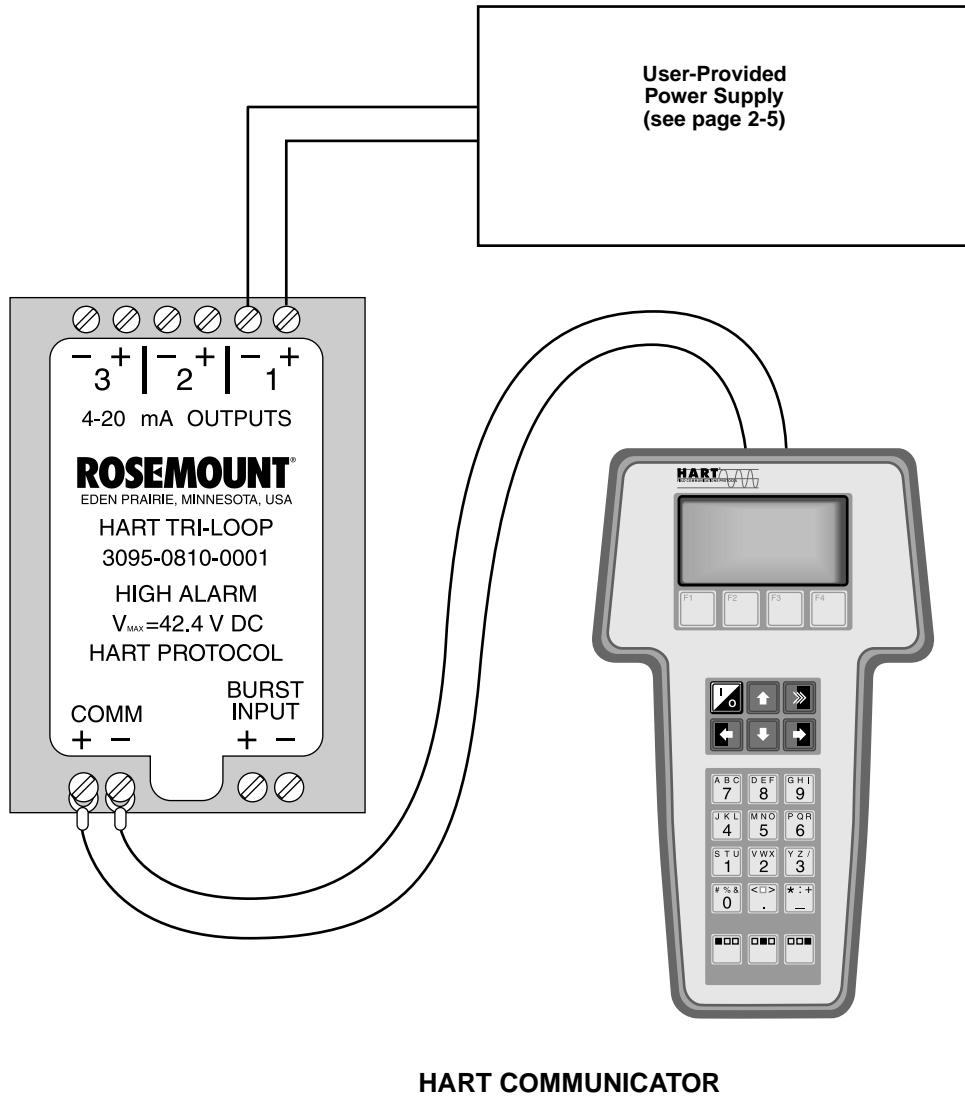

3095-3095_2A

COMMUNICATOR KEYS

The keys of the HART Communicator include action, function, alphanumeric, and shift keys

FIGURE B-4. The HART Communicator.

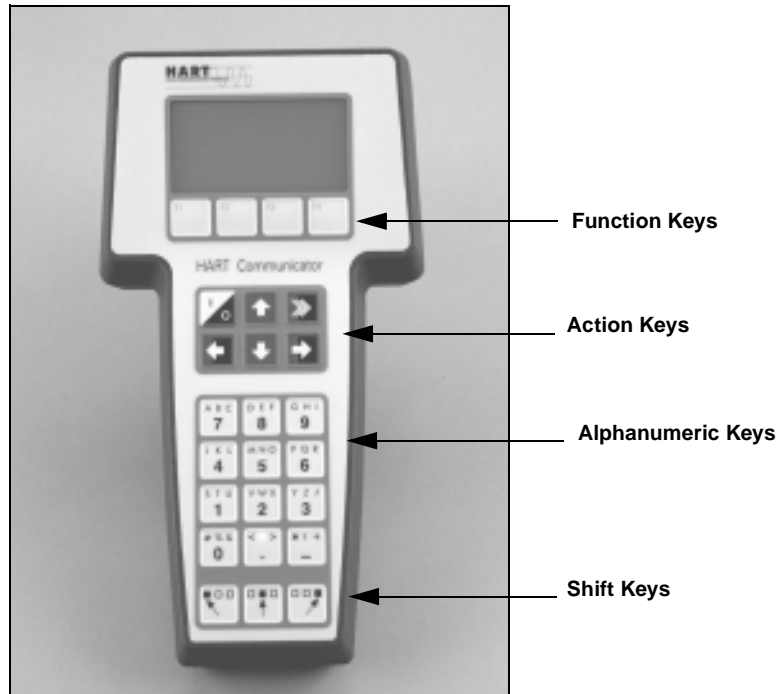

275-011AB

Action Keys

As shown in Figure B-4, the action keys are the six blue, white, and black keys located above the alphanumeric keys. The function of each key is described as follows:

ON/OFF Key

Use this key to power the HART Communicator. When the communicator is turned on, it searches for a transmitter on the 4–20 mA loop. If a device is not found, the communicator displays the message, “No Device Found. Press OK.”

If a HART-compatible device is found, the communicator displays the Online Menu with device ID and tag.

Directional Keys

Use these keys to move the cursor up, down, left, or right. The right arrow key also selects menu options, and the left arrow key returns to the previous menu.

HOT Key

Use this key to quickly access important, user-selectable options when connected to a HART-compatible device. Pressing the Hot Key turns the HART Communicator on and displays the Hot Key Menu. See Customizing the Hot Key Menu in the HART Communicator manual for more information.

Function Keys



Use the four software-defined function keys, located below the LCD, to perform software functions. On any given menu, the label appearing above a function key indicates the function of that key for the current menu. As you move among menus, different function key labels appear over the four keys. For example, in menus providing access to on-line help, the **HELP** label may appear above the F1 key. In menus providing access to the Online Menu, the **HOME** label may appear above the F3 key. Simply press the key to activate the function. See your HART Communicator manual for details on specific function key definitions.

Alphanumeric and Shift Keys

The alphanumeric keys (Figure A-5) perform two functions: the fast selection of menu options and data entry.

FIGURE B-5. HART Communicator Alphanumeric and Shift Keys.

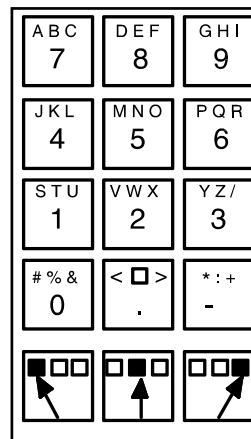

Data Entry

Some menus require data entry. Use the alphanumeric and shift keys to enter all alphanumeric information into the HART Communicator. If you press an alphanumeric key alone from within an edit menu, the bold character in the center of the key appears. These large characters include the numbers zero through nine, the decimal point (.), and the dash symbol (—).

To enter an alphabetic character, first press the shift key that corresponds to the position of the letter you want on the alphanumeric key. Then press the alphanumeric key. For example, to enter the letter “R,” press and release the right shift key, then press and release the “6” key (see Figure B-6). Do not press these keys simultaneously.

FIGURE B-6. Data Entry Key Sequence.



Fast Key Sequences

HART fast key sequences provide quick on-line access to transmitter variables and functions. Instead of stepping your way through the menu structure using the action keys, you can press a HART fast key sequence to move from the Online Menu to the desired variable or function. On-screen instructions guide you through the rest of the screens.

Fast Key Sequence Conventions

The fast key sequences for the Model 275 use the following conventions for their identification:

1 through 9—Refer to the keys located directly below the dedicated keypad.

Left Arrow—Refers to the left arrow directional key.

Fast Key Sequence Example

HART fast key sequences are made up of the series of numbers corresponding to the individual options in each step of the menu structure. For example, from the Online Menu you can change the **Poll Addr**. Following the menu structure, press 1 to reach **Device Setup**, press 3 for **Detailed Setup**, press 1 for **Output Condition**, press 2 for **HART Output**, and 1 for **Poll Addr**. The corresponding HART fast key sequence is 1, 3, 1, 2, 1.

HART fast keys are operational only from the Online Menu. If you use them consistently, you will need to return to the Online Menu by pressing **HOME** (F3) when it is available. If you do not start at the Online Menu, the HART fast key sequences will not function properly.

Use Table B-1, an alphabetical listing of every on-line function, to find the corresponding HART fast key sequences. These codes are applicable only to Level Controller and the HART Communicator.

MENUS AND FUNCTIONS

The HART Communicator is a menu driven system. Each screen provides a menu of options that can be selected as outlined above, or provides direction for input of data, warnings, messages, or other instructions.

Main Menu

When the HART Communicator is turned on, one of two menus will appear. If the HART Communicator is connected to an operating loop, the communicator will find the device and display the Online Menu (see below). If it is not connected to a loop, the communicator will indicate that no device was found. When you press OK (F4), it will display the Main menu.

The Main menu provides the following options:

- *Offline*—The Offline option provides access to offline configuration data and simulation functions.
- *Online*—The Online option checks for a device and if it finds one, brings up the Online Menu.
- *Transfer*—The Transfer option provides access to options for transferring data either from the HART Communicator (memory) to the transmitter (device) or vice versa. Transfer is used to move off-line data from the HART Communicator to the transmitter, or to retrieve data from a transmitter for off-line revision.

NOTE

Online communication with the transmitter automatically loads the current transmitter data to the HART Communicator. Changes in on-line data are made active by pressing SEND (F2). The transfer function is used only for off-line data retrieval and sending.

- *Frequency Device*—The Frequency Device option displays the frequency output and corresponding pressure output of current-to-pressure transmitters.
- *Utility*—The Utility option provides access to the contrast control for the HART Communicator LCD screen and to the autopoll setting used in multidrop applications.

Once selecting a Main menu option, the HART Communicator provides the information you need to complete the operation. If further details are required, consult the HART Communicator manual.

Online Menu

The Online Menu can be selected from the Main menu as outlined above, or it may appear automatically if the HART Communicator is connected to an active loop and can detect an operating transmitter.

NOTE

The Main menu can be accessed from the Online Menu. Press the left arrow action key to deactivate the on-line communication with the transmitter and to activate the Main menu options.

When configuration variables are reset in the on-line mode, the new settings are not activated until the information is sent to the transmitter. Press SEND (F2) when it is activated to update the process variables of the transmitter.

On-line mode is used for direct evaluation of a particular meter, re-configuration, changing parameters, maintenance, and other functions.

Diagnostic Messages

The following pages contain a list of messages used by the HART Communicator (HC) and their corresponding descriptions.

Variable parameters within the text of a message are indicated with *<variable>*.

Reference to the name of another message is identified by *<message>*.

Message	Description
Add item for ALL device types or only for this ONE device type.	Asks the user whether the hot key item being added should be added for all device types or only for the type of device that is connected.
Command Not Implemented	The connected device does not support this function.
Communication Error	Either a device sends back a response indicating that the message it received was unintelligible, or the HC cannot understand the response from the device.
Configuration memory not compatible with connected device	The configuration stored in memory is incompatible with the device to which a transfer has been requested.
Device Busy	The connected device is busy performing another task.
Device Disconnected	Device fails to respond to a command.
Device write protected	Device is in write-protect mode. Data can not be written.
Device write protected. Do you still want to shut off?	Device is in write-protect mode. Press YES to turn the HC off and lose the unsent data.
Display value of variable on hotkey menu?	Asks whether the value of the variable should be displayed adjacent to its label on the hotkey menu if the item being added to the hotkey menu is a variable.
Download data from configuration memory to device	Prompts user to press SEND softkey to initiate a memory to device transfer.
Exceed field width	Indicates that the field width for the current arithmetic variable exceeds the device- specified description edit format.
Exceed precision	Indicates that the precision for the current arithmetic variable exceeds the device- specified description edit format.
Ignore next 50 occurrences of status?	Asked after displaying device status. Softkey answer determines whether next 50 occurrences of device status will be ignored or displayed.
Illegal character	An invalid character for the variable type was entered.
Illegal date	The day portion of the date is invalid.
Illegal month	The month portion of the date is invalid.
Illegal year	The year portion of the date is invalid.
Incomplete exponent	The exponent of a scientific notation floating point variable is incomplete.
Incomplete field	The value entered is not complete for the variable type.
Looking for a device	Polling for multidropped devices at addresses 1–15.

Message	Description
Mark as read only variable on hotkey menu?	Asks whether the user should be allowed to edit the variable from the hotkey menu if the item being added to the hotkey menu is a variable.
No device configuration in configuration memory	There is no configuration saved in memory available to re-configure off-line or transfer to a device.
No Device Found	Poll of address zero fails to find a device, or poll of all addresses fails to find a device if auto-poll is enabled.
No hotkey menu available for this device.	There is no menu named "hotkey" defined in the device description for this device.
No offline devices available.	There are no device descriptions available to be used to configure a device offline.
No simulation devices available.	There are no device descriptions available to simulate a device.
No UPLOAD_VARIABLES in ddl for this device	There is no menu named "upload_variables" defined in the device description for this device. This menu is required for offline configuration.
No Valid Items	The selected menu or edit display contains no valid items.
OFF KEY DISABLED	Appears when the user attempts to turn the HC off before sending modified data or before completing a method.
Online device disconnected with unsent data. RETRY or OK to lose data.	There is unsent data for a previously connected device. Press RETRY to send data, or press OK to disconnect and lose unsent data.
Out of memory for hotkey configuration. Delete unnecessary items.	There is no more memory available to store additional hotkey items. Unnecessary items should be deleted to make space available.
Overwrite existing configuration memory	Requests permission to overwrite existing configuration either by a device-to-memory transfer or by an offline configuration. User answers using the softkeys.
Press OK...	Press the OK softkey. This message usually appears after an error message from the application or as a result of HART communications.
Restore device value?	The edited value that was sent to a device was not properly implemented. Restoring the device value returns the variable to its original value.
Save data from device to configuration memory	Prompts user to press SAVE softkey to initiate a device-to-memory transfer.
Saving data to configuration memory.	Data is being transferred from a device to configuration memory.
Sending data to device.	Data is being transferred from configuration memory to a device.
There are write only variables which have not been edited. Please edit them.	There are write-only variables which have not been set by the user. These variables should be set or invalid values may be sent to the device.

Message	Description
There is unsend data. Send it before shutting off?	Press YES to send unsend data and turn the HC off. Press NO to turn the HC off and lose the unsend data.
Too few data bytes received	Command returns fewer data bytes than expected as determined by the device description.
Transmitter Fault	Device returns a command response indicating a fault with the connected device.
Units for <variable> has changed. Unit must be sent before editing, or invalid data will be sent.	The engineering units for this variable have been edited. Send engineering units to the device before editing this variable.
Unsend data to online device. SEND or LOSE data	There is unsend data for a previously connected device which must be sent or thrown away before connecting to another device.
Use up/down arrows to change contrast. Press DONE when done.	Gives direction to change the contrast of the HC display.
Value out of range	The user-entered value is either not within the range for the given type and size of variable or not within the min/max specified by the device.
<message> occurred reading/writing <variable>	Either a read/write command indicates too few data bytes received, transmitter fault, invalid response code, invalid response command, invalid reply data field, or failed pre- or post-read method; or a response code of any class other than SUCCESS is returned reading a particular variable.
<variable> has an unknown value. Unit must be sent before editing, or invalid data will be sent.	A variable related to this variable has been edited. Send related variable to the device before editing this variable.

Rosemount Inc.

8200 Market Boulevard
Chanhassen, MN 55317 USA
Tel 1-800-999-9307
Fax (612) 949-7001
© 1999 Rosemount, Inc.



<http://www.rosemount.com>

Fisher-Rosemount Limited

Heath Place
Bognor Regis
West Sussex PO22 9SH
England
Tel 44 (1243) 863 121
Fax 44 (1243) 867 5541

**Fisher-Rosemount
Singapore Pte Ltd.**

1 Pandan Crescent
Singapore 128461
Tel (65) 777-8211
Fax (65) 777-0947



00809-0100-4754 Rev. BB 09/99

ROSEMOUNT®

FISHER-ROSEMOUNT™ Managing The Process Better.™