

Rosemount™ 2090F Hygienic Pressure Transmitter



- Conforms to 3-A® Sanitary Standards
- Features CIP/SIP service for process temperatures up to 284 °F (140 °C)
- Absolute or gage pressure ranges up to 300 psi
- Mounts with either 1½ or 2-in. Tri Clamp connection
- Performance of 0.10% with high accuracy option

Accurate, stable, and reliable pressure measurement for the hygienic industries

Conforms to 3-A Sanitary Standards

The hygienic design of the Rosemount 2090F conforms to 3-A Sanitary Standards, and is USDA accepted. The materials of construction are Generally Recognized As Safe (GRAS) by the FDA, making it the ideal choice for any hygienic application.

Features CIP/SIP service with an upper temperature limit of 284 °F (140 °C)

The Rosemount 2090F provides accurate, stable, and reliable pressure measurement, which makes it an ideal choice for pharmaceutical and food and beverage applications, including CIP/SIP service for process temperatures up to 284 °F (140 °C).

Absolute or gauge pressure ranges up to 300 psi and 20:1 turndown

Higher turndown allows for lower inventories by allowing you to measure pressures from 1.5 psi to 300 psi with only three transmitter ranges.

Mounts with either 1½ or 2-in. Tri Clamp connection

The Rosemount 2090F is available with both 1½-in. and 2-in. Tri Clamp process connections, designed for sanitary applications to easily connect to standard sanitary fittings without requiring special mounting hardware.

0.10% reference accuracy performance with P8 high accuracy option

The single-filled sensor system of the Rosemount 2090P leads to outstanding accuracy due to full sensor compensation.

Contents

Ordering information	3	Product Certifications	8
Specifications	6	Dimensional drawings	12

Ordering information

Specification and selection of product materials, options, or components must be made by the purchaser of the equipment. See [page 7](#) for more information on Material Selection.

Table 1. Rosemount 2090F Pressure Transmitter Ordering Information

★ The Standard offering represents the most common options. The starred options (★) should be selected for best delivery. The Expanded offering is manufactured after receipt of order and is subject to additional delivery lead time.

Model	Product description			
2090F	Hygienic Pressure Transmitter			
Transmitter type				
A	Absolute			★
G	Gage			★
Pressure ranges (range/minimum span)				
	Rosemount 2090FG	Rosemount 2090FA		
1	-14.7 to 30 psi/1.5 psi (-1,01 to 2,1 bar/103 mbar)	0 to 30 psia/1.5 psi (0 to 2,1 bar/103 mbar)		★
2	-14.7 to 150 psi/7.5 psi (-1,01 to 10,3 bar/517 mbar)	0 to 150 psia/7.5 psi (0 to 10,3 bar/517 mbar)		★
3	-14.7 to 300 psi/40 psi (-1.01 to 20,7 bar/2,8 bar)	0 to 300 psia/40 psi (0 to 20,7 bar/2,8 bar)		★
Output				
S	4–20 mA dc/digital HART® Protocol			★
Material of construction				
	Process connection	Isolating diaphragm	Oil fill	
2D	316L SST	316L SST	Neobee®	★
Process connection				
E	1½-in. Tri Clamp connection			★
F	2-in. Tri Clamp connection			★
Conduit entry				
1	½–14 NPT			★
2	M20 × 1.5 female			★

Options (include with selected model number)

Extended product warranty			
WR3	3-year limited warranty		★
WR5	5-year limited warranty		★
Digital display			
M5	LCD display, configured for percent of range		★
Mounting brackets			
B4	SST mounting bracket with SST bolts		★

Table 1. Rosemount 2090F Pressure Transmitter Ordering Information

★ The Standard offering represents the most common options. The starred options (★) should be selected for best delivery. The Expanded offering is manufactured after receipt of order and is subject to additional delivery lead time.

Product certifications		
E5	USA Explosionproof (XP) and Dust-Ignitionproof (DIP)	★
ED	ATEX Flameproof	★
EM	Technical Regulations Customs Union (EAC) Flameproof	★
I5	USA Intrinsic Safety (IS) and Nonincendive (NI)	★
K5	USA Explosionproof (XP), Dust-Ignitionproof (DIP), Intrinsic Safety (IS), and Nonincendive (NI)	★
I1	ATEX Intrinsic Safety	★
N1	ATEX Type n	★
C6	Canada Explosionproof, Intrinsic Safety, Division 2, and Dust-Ignitionproof	★
KB	USA Explosionproof, Dust-Ignitionproof, Intrinsic Safety, Nonincendive and Canada Explosionproof, Intrinsic Safety, Division 2, and Dust-Ignitionproof	★
KM	Technical Regulation Customs Union (EAC) Flameproof and Intrinsic Safety	★
KH	ATEX Flameproof, Intrinsic Safety, USA Explosionproof, Dust-Ignitionproof, Intrinsic Safety, and Nonincendive	★
ND	ATEX Dust	★
NK	IECEX Dust	★
K7	IECEX Flameproof, Dust, Intrinsic Safety, Type n	★
K1	ATEX Flameproof, Dust, Intrinsic Safety, Type n	★
K6	Canada Explosion-Proof, Intrinsic Safety, Division 2, Dust-ignitionproof, and ATEX Flameproof, Intrinsic Safety	★
I3	China Intrinsic Safety	★
IM	Technical Regulation Customs Union (EAC) Intrinsic Safety	★
E3	China Flameproof	★
Terminal blocks		
T1	Transient protection	★
Special certificate		
Q4	Calibration certificate	★
Quality calibration certificate traceability certification		
Q8	Material traceability certification per EN 10204 3.1	★
Alarm limit		
C4	NAMUR alarm and saturation levels, high alarm	★
CN	NAMUR alarm and saturation levels, low alarm	★
Special procedures		
P2	Cleaning for special service	
Calibration accuracy		
P8	0.1% accuracy to 10:1 turndown	★
Typical model number: 2090F G 2 S 2D E 1		

Standard configuration

Unless otherwise specified, transmitter is shipped as follows:

- Engineering units: psi
- 4 mA: 0 psi
- 20 mA: Upper range limit
- Alarm output: high
- LCD display: 0–100%

Custom configuration

Calibration

Transmitters are factory calibrated to customer's specified range. If calibration is not specified, transmitters are calibrated at maximum range. Calibration is at ambient temperature and pressure.

Tagging

The transmitter will be tagged, at no charge, in accordance with customer requirements. All tags are stainless steel. The standard tag is wired to the transmitter. Tag character height is 1/8-in. (0.318 cm). A permanently attached tag is available upon request.

Accessories

Item description	Part number
Calibration adapter, 1 1/2-in. Use to connect a calibration device to a transmitter.	02088-0197-0011
Calibration adapter, 2-in. Use to connect a calibration device to a transmitter.	02088-0197-0012

Specifications

Functional specifications

Service

Liquid, gas, vapor, and high-viscosity applications

Ranges

Range	Minimum span	Upper (URL)	Lower (LRL)	Lower ⁽¹⁾ (LRL)(gage)
1	1.5 psi (103 mbar)	30 psi (2,1 bar)	0 psia (0 bar)	-14.7 psig (-1,01 bar)
2	7.5 psi (517 mbar)	150 psi (10,3 bar)	0 psia (0 bar)	-14.7 psig (-1,01 bar)
3	40 psi (2,76 bar)	300 psi (20,7 bar)	0 psia (0 bar)	-14.7 psig (-1,01 bar)

1. Assumes atmospheric pressure of 14.7 psig.

Output

4–20 mA Selectable HART Protocol

Range down

20:1

Load limitations

Maximum loop resistance is determined by the power supply voltage, as described by the following equation:

Maximum loop resistance = 43.5 (Power supply voltage – 10.5)

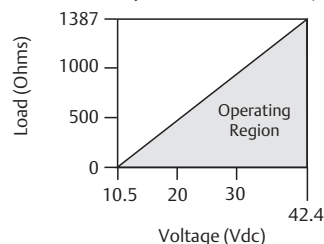

The Field Communicator requires a minimum loop resistance of 250 Ω for communication.

Power supply

External power supply required. Transmitter operates on 10.5–42.4 V dc with no load. Reverse polarity protection is standard.

Overpressure limits

Range	Overpressure limit ⁽¹⁾
1	120 psi (8,3 bar)
2	300 psi (20,7 bar)
3	600 psi (41,4 bar)

1. Overpressure limit is dependent on the clamp/pressure adapter or sensor rating (whichever is lower).

Temperature limits

Process

–4 to 284 °F (–20 to 140 °C)

Ambient

–4 to 185 °F (–20 to 85 °C)

Storage

–22 to 185 °F (–30 to 85 °C)

Process temperatures above 185 °F (85 °C) require lowering the ambient limits by a 1.5:1 ratio:

$$\text{Max. ambient temperature in } ^\circ\text{F} = 185 - \frac{(\text{Process Temp} - 185)}{1.5}$$

$$\text{Max. ambient temperature in } ^\circ\text{C} = 85 - \frac{(\text{Process Temp} - 85)}{1.5}$$

Humidity limits

0–100% relative humidity

Volumetric displacement

Less than 0.0005 in³ (0,008 cm³)

Turn-on time

Performance within specifications less than 2.0 seconds after power is applied to the transmitter

Failure alarm

If self-diagnostics detect a sensor or microprocessor failure, the analog signal is driven either high or low to alert the user. High or low failure mode is user-selectable by a jumper on the transmitter. The values to which the transmitter drives its output in failure mode depend on whether it is factory-configured to standard or NAMUR-compliant operation. The values for each are as follows:

Standard operation

Linear output: 3.9 ≤ I ≤ 20.8
 Fail high: I ≥ 21.75 mA
 Low: I ≤ 3.75 mA

NAMUR-compliant operation

Linear output: 3.8 ≤ I ≤ 20.5
 Fail high: I ≥ 22.5 mA
 Low: I ≤ 3.6 mA

Transmitter security

Activating the transmitter security function prevents changes to the transmitter configuration, including local zero and span adjustments. Security is activated by an internal jumper.

Performance specifications

Zero-based spans, reference conditions, and 316 SST isolating diaphragm

Reference accuracy

±0.20% of calibrated span. Includes combined effects of linearity, hysteresis, and repeatability.

High accuracy (P8) option:

±0.10% of calibrated span to 10:1 turndown

Ambient temperature effect per 50 °F (28 °C)

±(0.15% URL + 0.15% span) from 1:1 to 20:1

Stability

±0.10% of URL for 1 year, reference stability

Time response

Total response time⁽¹⁾

145 ms

Update rate

22 times per second

1. Nominal total response time at 75 °F (24 °C) reference conditions.

Vibration effect

Less than ±0.1% of upper range limit when subjected to vibration of peak to peak constant displacement of 4 mm (5–15 Hz) and constant acceleration of 2 g (15–150 Hz) and 1 g (150–2000 Hz)

Power supply effect

Less than ±0.005% of calibrated span per volt

Electromagnetic compatibility (EMC)

Meets all industrial environment requirements of EN61326 and NAMUR NE-21⁽¹⁾. Maximum deviation < 1% span during EMC disturbance⁽²⁾.

1. NAMUR NE-21 does not apply to Low-Power (Transmitter output option code N).
2. During surge event device may exceed maximum EMC deviation limit or reset; however, device will self-recover and return to normal operation within specified start-up time.

Mounting position effect

Zero shift of up to 5.0 inH₂O (12,4 mbar), which can be calibrated out. No span effect.

Physical specifications

Material selection

Emerson provides a variety of Rosemount product with various product options and configurations including materials of construction that can be expected to perform well in a wide range of applications. The Rosemount product information presented is intended as a guide for the purchaser to make an appropriate selection for the application. It is the purchaser's sole responsibility to make a careful analysis of all process parameters (such as all chemical components, temperature, pressure, flow rate, abrasives, contaminants, etc.), when specifying product, materials, options and components for the particular application. Emerson Process Management is not in a position to evaluate or guarantee the compatibility of the process fluid or other process parameters with the product, options, configuration or materials of construction selected.

Electrical connection

1/2-14 NPT or M20 × 1.5 conduit entry

Process wetted parts

Isolating diaphragm

316L stainless steel

Process connector

316L stainless steel

Non-wetted parts

Electronics housing

Low-copper aluminum

Enclosures meet NEMA[®] Type 4X, IP66, and IP68 when properly installed

Paint

Polyurethane

Cover O-rings

Buna-N

Paint

Polyurethane

Cover O-rings

Buna-N

Fill fluid

Neobee M-20

Weight

Approximately 2.74 lb (1,24 kg)

Product Certifications

Rev 1.6

European Directive Information

A copy of the EU Declaration of Conformity can be found at the end of the Quick Start Guide. The most recent revision of the EU Declaration of Conformity can be found at EmersonProcess.com/Rosemount.

Ordinary Location Certification

As standard, the transmitter has been examined and tested to determine that the design meets the basic electrical, mechanical, and fire protection requirements by a nationally recognized test laboratory (NRTL) as accredited by the Federal Occupational Safety and Health Administration (OSHA).

North America

- E5** USA Explosionproof (XP) and Dust-Ignitionproof (DIP)
Certificate: 1V2A8.AE
Standards: FM Class 3600 – 2011, FM Class 3615 – 2006, FM class 3616 – 2011, FM Class 3810 – 2005, ANSI/NEMA 250 – 1991
Markings: XP CL I, DIV 1, GP B, C, D; DIP CL II, DIV 1, GP E, F, G; CL III, DIV 1; T5(−40 °C ≤ T_a ≤ +85 °C); Factory Sealed; Type 4X
- I5** USA Intrinsic Safety (IS) and Nonincendive (NI)
Certificate: 0V9A7.AX
Standards: FM Class 3600 – 1998, FM Class 3610 – 2010, FM Class 3611 – 2004, FM Class 3810 – 1989
Markings: IS CL I, DIV 1, GP A, B, C, D; CL II, DIV 1, GP E, F, G; Class III; DIV 1 when connected per Rosemount drawing 02088-1018; NI CL 1, DIV 2, GP A, B, C, D; T4(−40 °C ≤ T_a ≤ +70 °C); Type 4x

Special Condition for Safe Use (X):

1. The Rosemount 2090 Transmitter with the transient terminal block (option code T1) will not pass the 500 V r.m.s. dielectric strength test and this must be taken into account during installation.
- C6** Canada Explosionproof, Intrinsically Safe, and Division 2, Dust-Ignitionproof
Certificate: 1015441
Standards: CAN/CSA C22.2 No. 0-M91 (R2001), CSA Std C22.2 No. 25-1966, CSA Std C22.2 No. 30-M1986, CAN/CSA-C22.2 No. 94-M91, CSA Std C22.2 No. 142-M1987, CAN/CSA-C22.2 No. 157-92, CSA Std C22.2 No. 213-M1987, ANSI-ISA-12.27.01-2003

Markings: Explosionproof for Class I, Division 1, Groups B, C and D; Class II, Groups E, F, and G; Class III; Intrinsically Safe Class I, Division 1 when connected in accordance with Rosemount drawing 02088-1024, Temperature Code T3C; Ex ia; Class I Division 2 Groups A, B, C and D; Type 4X; Factory Sealed

Europe

- ED** ATEX Flameproof
Certificate: KEMA97ATEX2378X
Standards: EN60079-0:2012 + A11:2013, EN60079-1:2014, EN60079-26:2015
Markings: Ⓔ II 1/2 G Ex db IIC T6... T4, T6(−60 °C ≤ T_a ≤ +70 °C), T4/T5(−60 °C ≤ T_a ≤ +80 °C)

Special Condition for Safe Use (X):

1. This device contains a thin wall diaphragm. Installation, maintenance and use shall take into account the environmental conditions to which the diaphragm will be subjected. The manufacturer’s instructions for installation and maintenance shall be followed in detail to assure safety during its expected lifetime.
2. Flameproof joints are not intended for repair.
3. Non-standard paint options may cause risk from electrostatic discharge. Avoid installations that could cause electrostatic build-up on painted surfaces, and only clean the painted surfaces with a damp cloth. If paint is ordered through a special option code, contact the manufacturer for more information.

- I1** ATEX Intrinsic Safety
Certificate: BAS00ATEX1166X
Standards: EN60079-0:2012, EN60079-11:2012
Markings: Ⓔ II 1 G Ex ia IIC T4 Ga (−55 °C ≤ T_a ≤ +70 °C)

Table 2. Input Parameters

Parameter	HART
Voltage U _i	30 V
Current I _i	200 mA
Power P _i	0.9 W
Capacitance C _i	0.012 μF

Special Condition for Safe Use (X):

1. The apparatus is not capable of withstanding the 500 V insulation test required by EN60079-11. This must be taken into account when installing the apparatus.

- N1** ATEX Type n
Certificate: BAS00ATEX3167X
Standards: EN60079-0:2012, EN60079-15:2010
Markings: Ⓔ II 3 G Ex nA IIC T5 Gc (−40 °C ≤ T_a ≤ +70 °C)

Special Condition for Safe Use (X):

1. This apparatus is not capable of withstanding the 500 V insulation test that is required by EN60079-15. This must be taken into account when installing the apparatus.

ND ATEX Dust

Certificate: BAS01ATEX1427X

Standards: EN60079-0:2012, EN60079-31:2009

Markings: Ex t IIIC T 50 °C T₅₀₀ 60 °C Da**Special Conditions for Safe Use (X):**

1. The user must ensure that the maximum rated voltage and current (36 volts, 24 milliamperes, d.c.) are not exceeded. All connection to other apparatus or associated apparatus shall have control over this voltage and current to a category 'ib' circuit.
2. Cable entries must be used which maintain the ingress protection of the enclosure to at least IP66.
3. Unused cable entries must be filled with suitable blanking plugs which maintain the ingress protection of the enclosure to at least IP66.
4. Cable entries and blanking plugs must be suitable for the ambient range of the apparatus and capable of withstanding a 7 J impact test.
5. The Rosemount 2090 sensor module must be securely screwed in place to maintain the ingress protection of the enclosure.

International**K7** Combination

IECEX Flameproof

Certificate: IECEX KEM 06.0021X

Standards: IEC60079-0:2011, IEC60079-1:2014,

IEC60079-26:2014

Markings: Ex db IIC T6...T4 Ga/Gb, T6(-60 °C ≤ T_a ≤ +70 °C), T4/T5(-60 °C ≤ T_a ≤ +80 °C);**Special Conditions for Safe Use (X):**

1. This device contains a thin wall diaphragm. Installation, maintenance and use shall take into account the environmental conditions to which the diaphragm will be subjected. The manufacturer's instructions for installation and maintenance shall be followed in detail to assure safety during its expected lifetime.
2. Flameproof joints are not intended for repair.
3. Non-standard paint options may cause risk from electrostatic discharge. Avoid installations that could cause electrostatic build-up on painted surfaces, and only clean the painted surfaces with a damp cloth. If paint is ordered through a special option code, contact the manufacturer for more information.

IECEX Dust

Certificate: IECEX BAS12.0073X

Standards: IEC60079-0:2011, IEC60079-31:2008

Markings: Ex t IIIC T 50 °C T₅₀₀ 60 °C Da**Table 3. Input Parameters**

Parameter	HART
Voltage U _i	36 Vdc
Current I _i	24 mA

Special Conditions for Safe Use (X):

1. Cable entries must be used which maintain the ingress protection of the enclosure to at least IP66.
2. Unused cable entries must be filled with suitable blanking plugs which maintain the ingress protection of the enclosure to at least IP66.
3. Cable entries and blanking plugs must be suitable for the ambient temperature range of the apparatus and capable of withstanding a 7 J impact test.

IECEX Intrinsic Safety

Certificate: IECEX BAS 12.0071X

Standards: IEC60079-0:2011, IEC60079-11:2011

Markings: Ex ia IIC T5/T4 Ga, T5(-55 °C ≤ T_a ≤ +40 °C), T4(-55 °C ≤ T_a ≤ +70 °C)**Table 4. Input Parameters**

Parameter	HART
Voltage U _i	30 V
Current I _i	200 mA
Power P _i	0.9 W
Capacitance C _i	0.012 μF

Special Conditions for Safe Use (X):

1. When fitted with a transient suppression terminal block, the Rosemount 2090 is incapable of passing the 500 V isolation test. This must be taken into account during installation.
2. The enclosure may be made of aluminum alloy and given a protective polyurethane paint finish; however, care should be taken to protect it from impact or abrasion if located in a Zone 0 environment.

IECEX Type n

Certificate: IECEX BAS 12.0072X

Standards: IEC60079-0:2011, IEC60079-15:2010

Markings: Ex nA IIC T5 Gc (-40 °C ≤ T_a ≤ +70 °C)**Special Condition for Safe Use (X):**

1. When fitted with a transient suppression terminal block, the Rosemount 2090 is incapable of passing the 500 V isolation test. This must be taken into account during installation.

NK IECEx Dust
 Certificate: IECEx BAS12.0073X
 Standards: IEC60079-0:2011, IEC60079-31:2008
 Markings: Ex t IIC T 50 °C T₅₀₀ 60 °C Da

Table 5. Input Parameters

Parameter	HART
Voltage U _i	36 Vdc
Current I _i	24 mA

Special Conditions for Safe Use (X):

1. Cable entries must be used which mention the ingress protection of the enclosure to at least IP66.
2. Unused cable entries must be filled with suitable blanking plugs which maintain the ingress protection of the enclosure to at least IP66.
3. Cable entries and blanking plugs must be suitable for the ambient range of the apparatus and capable of withstanding a 7 J impact test.

China

E3 China Flameproof
 Certificate: GYJ15.1506X
 Standards: GB3836.1-2010, GB3836.2-2010
 Markings: Ex d IIC T6/T4 Gb, T6(-20 °C ≤ T_a ≤ +40 °C), T4(-20 °C ≤ T_a ≤ +80 °C)

Special Conditions for Safe Use (X):

1. The ambient temperature is as follows:

T _a	Temperature class
-20 °C ≤ T _a ≤ 80 °C	T4
-20 °C ≤ T _a ≤ 40 °C	T6

2. The earth connection facility in the enclosure should be connected reliably.
3. During installation in hazardous location, cable glands, conduits, and blanking plugs, certified by state-appointed inspection bodies with Ex d IIC type of protection, should be used.
4. During installation, use and maintenance in explosive gas atmospheres, observe the warning “Do not open when energized.”
5. During installation, there should be no mixture harm to flameproof housing.
6. End user is not permitted to change any components insides, but to settle the problem in conjunction with manufacturer to avoid damage to the product.
7. Maintenance should be done in non-hazardous location.
8. During installation, use and maintenance of this product, observe the following standards: GB3836.13-2013, GB3836.15-2000, GB3836.16-2006, GB50257-2014.

I3 China Intrinsic Safety
 Certificate: GYJ15.1508X
 Standards: GB3836.1-2010, GB3836.4-2010, GB3836.20-2010
 Markings: Ex ia IIC T4/T5 Ga

Special Conditions for Safe Use (X):

1. The enclosure may be made of aluminum alloy and given a protective polyurethane paint finish; however, care should be taken to protect it from impact or abrasion if located in a zone 0 environment.
2. This apparatus is not capable of withstanding the 500 V r.m.s. insulation test required by Clause 6.3.12 of GB3836.4-2010.
3. The ambient temperature is:

T _a	Temperature class
-55 °C ≤ T _a ≤ 40 °C	T5
-55 °C ≤ T _a ≤ 70 °C	T4

4. Intrinsically safe parameters:

Parameter	HART
Voltage U _i	30 V
Current I _i	200 mA
Power P _i	0.9 W
Capacitance C _i	0.012 μF
Inductance L _i	0 mH

5. The product should be used with Ex-certified linear associated apparatus to establish explosion protection system that can be used in explosive gas atmospheres. Wiring and terminals should comply with the instruction manual of the product and associated apparatus.
6. The cables between this product and associated apparatus should be shielded cables (the cables must have insulated shields). The shield has to be grounded reliably in a non-hazardous area.
7. End users are not permitted to change any internal components, but to settle the problem in conjunction with the manufacturer to avoid damage to the product.
8. During installation, use and maintenance of this product, observe the following standards: GB3836.13-2013, GB3836.15-2000, GB3836.16-2006, G3836.18-2010, GB50257-2014.

Technical Regulations Customs Union (EAC)

EM EAC Flameproof

Certificate: RU C-US.GB05.B.01197

Markings: Ga/Gb Ex d IIC T4/T6 X, T4(-40 °C ≤ T_a ≤ +80 °C), T6(-40 °C ≤ T_a ≤ +40 °C)

Special Condition for Safe Use (X):

See certificate for special conditions.

IM EAC Intrinsically Safe

Certificate: RU C-US.GB05.B.01197

Markings: 0Ex ia IIC T4 Ga X (-55 °C ≤ T_a ≤ +70 °C)

Special Conditions for Safe Use (X):

See certificate for special conditions.

Combinations

K1 Combination of ED, I1, ND, and N1

K5 Combination of E5 and I5

K6 Combination of C6, ED, and I1

K7 Combination of E7, I7, NK, and N7

KB Combination of K5 and C6

KM Combination of EM and IM

KH Combination of ED, I1, and K5

Conduit plugs and adapters

IECEx Flameproof and Increased Safety

Certificate: IECEx FMG 13.0032X

Standards: IEC60079-0:2011, IEC60079-1:2007, IEC60079-7:2006-2007

Markings: Ex de IIC Gb

ATEX Flameproof and Increased Safety

Certificate: FM13ATEX0076X

Standards: EN60079-0:2012, EN60079-1:2007, EN60079-7:2007

Markings:  II 2 G Ex de IIC Gb

Table 6. Conduit Plug Thread Sizes

Thread	Identification mark
M20 × 1.5	M20
1/2-14 NPT	1/2 NPT
G1/2A	G1/2

Table 7. Thread Adapter Thread Sizes

Male thread	Identification mark
M20 × 1.5 – 6H	M20
1/2-14 NPT	1/2-14 NPT
3/4-14 NPT	3/4-14 NPT
Female thread	Identification mark
M20 × 1.5 – 6H	M20
1/2-14 NPT	1/2-14 NPT
PG 13.5	PG 13.5

Special Conditions for Safe Use (X):

1. When the thread adapter or blanking plug is used with an enclosure in type of protection increased safety “e” the entry thread shall be suitably sealed in order to maintain the ingress protection rating (IP) of the enclosure.
2. The blanking plug shall not be used with an adapter.
3. Blanking Plug and Threaded Adapter shall be either NPT or Metric thread forms. G1/2 and PG 13.5 thread forms are only acceptable for existing (legacy) equipment installations.

Dimensional drawings

Figure 1. Rosemount 2090F

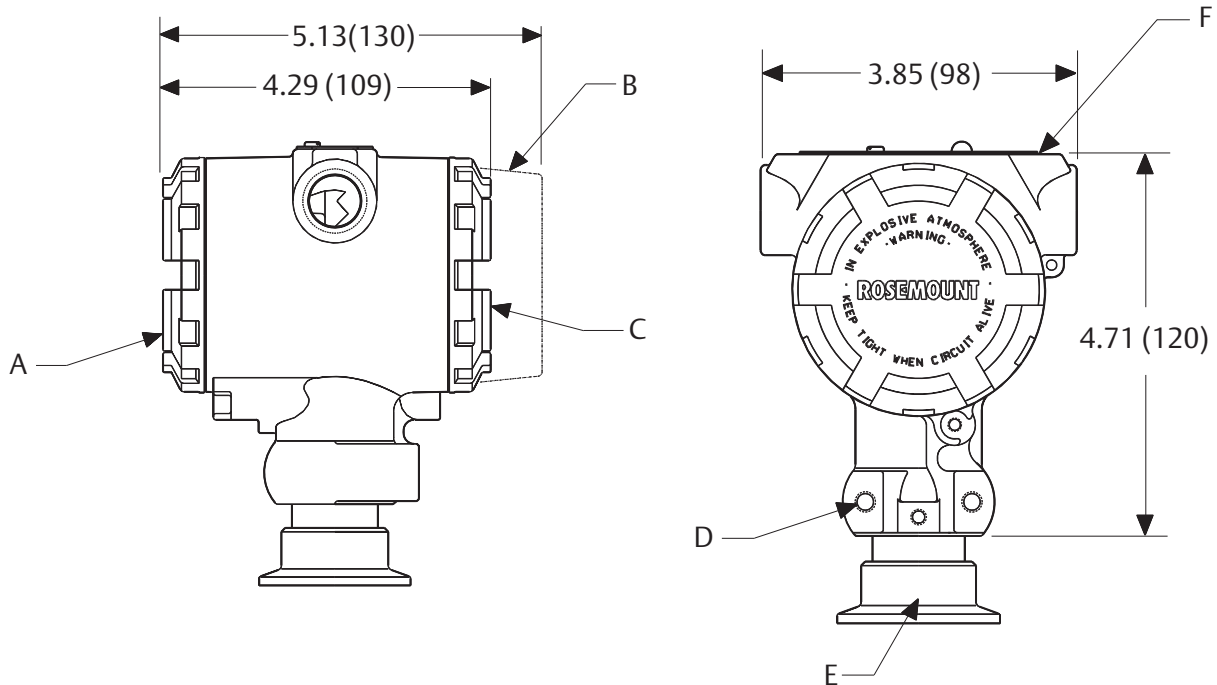

- A. Terminal connection side
 - B. Optional display
 - C. Transmitter circuitry side
- Note: M20 × 1.5 female is also available as option.
 Dimensions are in inches (millimeters).

- D. 2 × 1/4-20 UNC-2BX Depth 0.60 mounting holes
- E. 1 1/2- or 2-in. Tri Clamp connection
- F. Certification tag

Global Headquarters

Emerson Process Management
6021 Innovation Blvd.
Shakopee, MN 55379, USA
+1 800 999 9307 or +1 952 906 8888
+1 952 949 7001
RFQ.RMD-RCC@EmersonProcess.com

North America Regional Office

Emerson Process Management
8200 Market Blvd.
Chanhassen, MN 55317, USA
+1 800 999 9307 or +1 952 906 8888
+1 952 949 7001
RMT-NA.RCCRFQ@Emerson.com

Latin America Regional Office

Emerson Process Management
1300 Concord Terrace, Suite 400
Sunrise, FL 33323, USA
+1 954 846 5030
+1 954 846 5121
RFQ.RMD-RCC@EmersonProcess.com

Europe Regional Office

Emerson Process Management Europe GmbH
Neuhofstrasse 19a P.O. Box 1046
CH 6340 Baar
Switzerland
+41 (0) 41 768 6111
+41 (0) 41 768 6300
RFQ.RMD-RCC@EmersonProcess.com

Asia Pacific Regional Office

Emerson Process Management Asia Pacific Pte Ltd
1 Pandan Crescent
Singapore 128461
+65 6777 8211
+65 6777 0947
Enquiries@AP.EmersonProcess.com

Middle East and Africa Regional Office

Emerson Process Management
Emerson FZE P.O. Box 17033,
Jebel Ali Free Zone - South 2
Dubai, United Arab Emirates
+971 4 8118100
+971 4 8865465
RFQ.RMTMEA@Emerson.com

 [Linkedin.com/company/Emerson-Process-Management](https://www.linkedin.com/company/Emerson-Process-Management)

 [Twitter.com/Rosemount_News](https://twitter.com/Rosemount_News)

 [Facebook.com/Rosemount](https://www.facebook.com/Rosemount)

 [Youtube.com/user/RosemountMeasurement](https://www.youtube.com/user/RosemountMeasurement)

 [Google.com/+RosemountMeasurement](https://www.google.com/+RosemountMeasurement)

Standard Terms and Conditions of Sale can be found at:
www.Emerson.com/en-us/pages/Terms-of-Use
The Emerson logo is a trademark and service mark of Emerson Electric Co.
Rosemount and Rosemount logotype are trademarks of Emerson Process Management.
3-A is a registered trademark of 3-A Sanitary Standards, Inc.
HART is a registered trademark of the FieldComm Group.
NEMA is a registered trademark and service mark of the National Electrical Manufacturers Association.
Neobee is a registered trademark of Stepan Specialty Products, LLC.
All other marks are the property of their respective owners.
© 2016 Emerson Process Management. All rights reserved.